



For Android™ 11

Enterprise Mobility

PM351

User Manual

Instruction

This manual provides information about basic features and using the PM351. Please read this manual carefully before using your handy payment device and peripherals to ensure safe and proper use.

 **Note:** Screenshots in this manual may differ from actual screens.

 **Note:** Most of the device figures in this manual represent the PM351 Numeric type. If you want to know the Alpha-Numeric keypad information, please refer to [Keypad](#) chapter.

Revision History

Revision	Date	Description
V1.0	04 May 2022	Initial release
V2.0	27 Mar 2023	Updated Battery safety information chapter

Introduction

PM351 SKUs

The contents of this manual can cover the following SKUs.

SKU	Part Number	Network	RAM /Flash	Keypad	Scanner	Camera	Common
SKU1	P351G3T23BJE0T	WiFi/BT	3G/32G	Numeric	SE965	Top Camera	NFC Android GMS 11
SKU2	P351G3223BJE0C				SE4100		
SKU3	P351G3M23BJE0C						
SKU4	P351G3M23DJE0C		4G/64G		SE4710		
SKU5	P351G6M23BJE0C	LTE, GPS, WiFi/BT	3G/32G	Alpha Numeric	SE4100		
SKU6	P351G3263BJE0C	WiFi/BT					
SKU7	P351G6263BJE0C	LTE, GPS, WiFi/BT					

Table of Contents

INSTRUCTION	1
Revision History	1
PM351 SKUs	2
GETTING STARTED	7
Device Parts	7
Product Standard Accessories.....	9
Install SIM & SD card.....	10
About SIM card.....	11
About SD card	12
Install & Remove Battery	13
Install the battery	13
Remove the battery	14
Battery Hot Swap.....	14
Charge the device.....	15
Battery specification	15
Smart Charging	15
Charge with power adapter.....	17
Charging Cradle	18
LED Indicator	19
Turn on & off Device	20
Use a Touch Screen	21
Controlling the touch screen	21
System navigation	23
LEARNING THE BASICS.....	25
Setup Wizard	25
Home Screen.....	26

Table of Contents

Status bar	27
Notification panel	28
Quick setting panel	29
Apps & Widget.....	30
MTP Connection with PC	34
Manage the Files	35
Lock the Screen.....	37
Settings.....	38
Adjust display brightness	38
Adjust sound.....	38
Use Keyboard Backlight	39
Adjust font size	40
USING THE KEYPAD.....	41
Keypad.....	41
Numeric Keypad	41
Alpha-Numeric Keypad.....	45
Use the Buttons	49
Functions.....	49
Screenshot	49
Program buttons	50
CAMERA	52
SCANNER	53
Turn on / off the Scanner	53
ScanSettings.....	54
Basic.....	54
Options	55
Notification.....	56

Table of Contents

Wedge	57
Extended wedge	58
Symbologies	62
About	62
Scan a Barcode	63
SE965 Scanner SKU (SKU1)	63
SE4100 Scanner SKU (SKU2, 6, 7)	63
SE4710 Scanner SKU (SKU3, 4, 5)	63
ScanDemo	64
WIRELESS	65
Mobile Network (LTE SKU Only).....	65
Wi-Fi	66
Bluetooth.....	67
Turn on / off	67
Pair and Connect.....	67
Unpair and Disconnect	68
Change the Bluetooth device details	69
NFC	70
SYSTEM MAINTENANCE	71
System Information.....	71
On Settings.....	71
On EmKit	71
Check Device Health	72
OS Update	73
OS update via storage	73
OS update via OTG port.....	74
OS update via FOTA	74

Table of Contents

Factory Data Reset	76
Factory data reset via Settings app	76
Factory data reset via recovery mode	77
ACCESSORIES	78
Hand Strap.....	78
Mount hand strap.....	79
Gun Handle.....	80
Attach gun handle.....	80
Single Slot Cradle (SSC)	81
2 Slot Cradle (2SC).....	82
4SBC (4 Slot Battery Cradle)	83
SAFETY INFORMATION.....	84
Battery Safety Information	84

Getting Started

Device Parts

Figure 1 PM351 front view

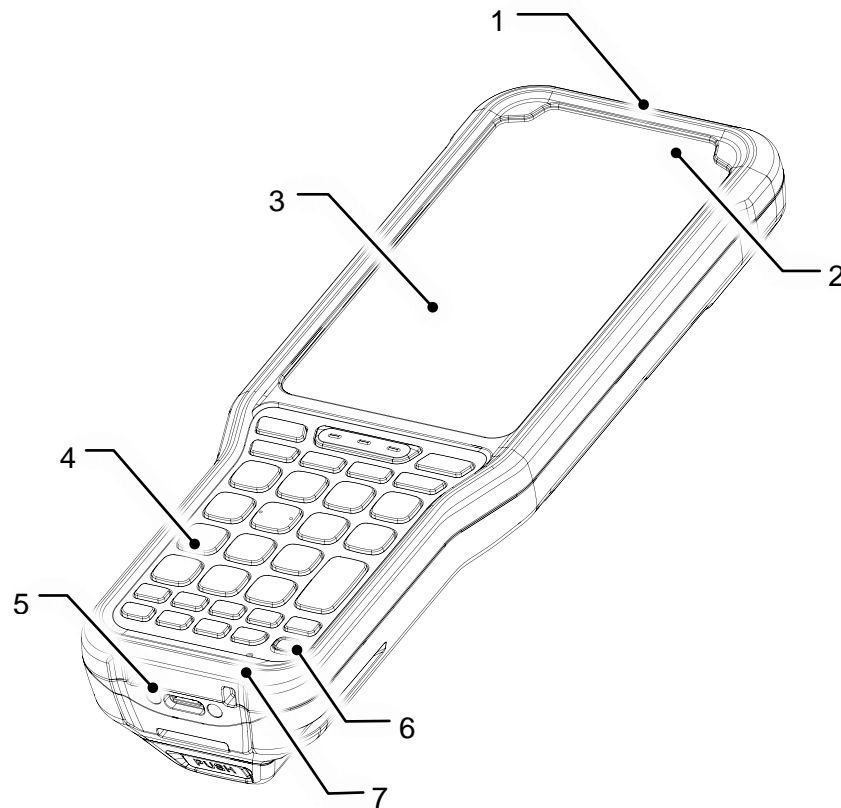

No	Name	Description
1	Scanner & Camera	Scans a barcode and take a picture
2	LED indicators	Indicates the power status and notification. Find more details in LED Indicator .
3	Touch screen	Displays all operating screen
4	Keypad	Numeric or Alpha numeric keypad (For more detail, refer to Using the Keypad)
5	USB Connector	USB 2.0 Type C / OTG
6	Power button	Turn on/off the device
7	Microphone	Captures the sound around

Getting Started

Figure 2 PM351 rear view

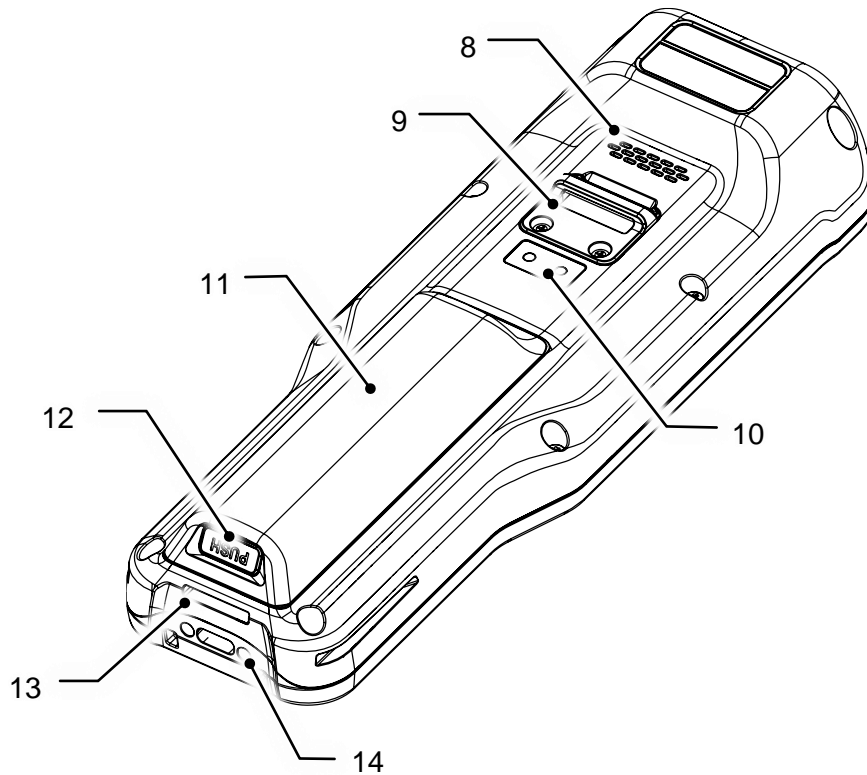







No	Name	Description
8	Speaker	Ring system sound
9	Hand strap hole (Top)	Mount hand strap
10	I/O connector (Rear)	Connector for communication with gun handle
11	Battery	Standard capacity battery
12	Battery release button	Press to release the battery
13	Hand strap hole (Bottom)	Mount hand strap
14	I/O connector (Bottom)	Connector for cradle communication (charging)

Getting Started

Product Standard Accessories

The following items are in the product box.

Accessory	Name
	Battery pack
	AC Plug
	5V 2A Power Adapter
	USB type C cable
	Hand strap
	Stylus pen
	LCD Protection Film



Note: The images may differ from the actual accessory.

Getting Started

Install SIM & SD card

PM351 supports

- Micro SIM card – LTE SKU (SKU 5, 7) only
- microSD card

Refer to the table to find out the difference.

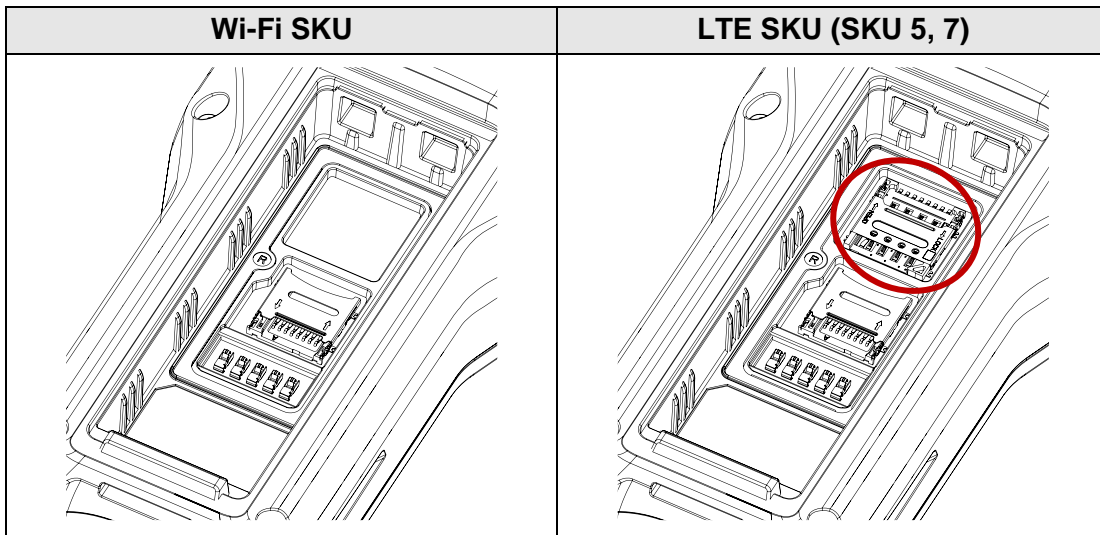

Getting Started

About SIM card

To install the SIM card,

1. Remove the battery while pressing the battery release button.
2. Gently slide the cardholder up, and swing upwards to open the holder.

Figure 3 Open SIM cardholder

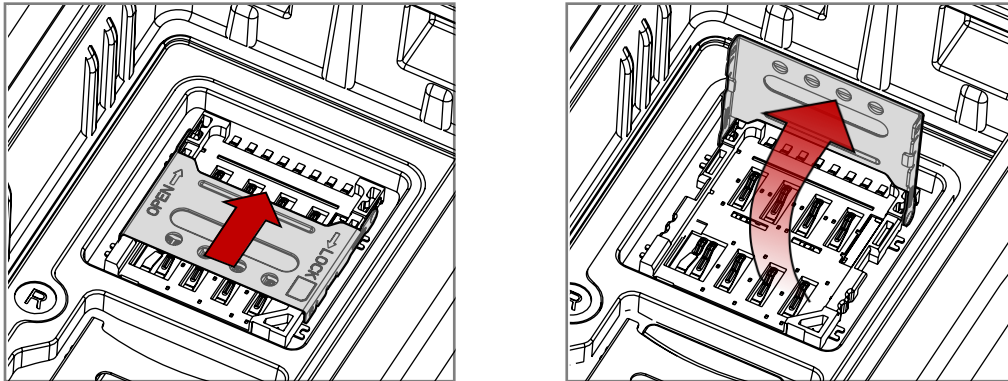

3. Put the SIM card facing down the gold contact.

Figure 4 Place SIM card

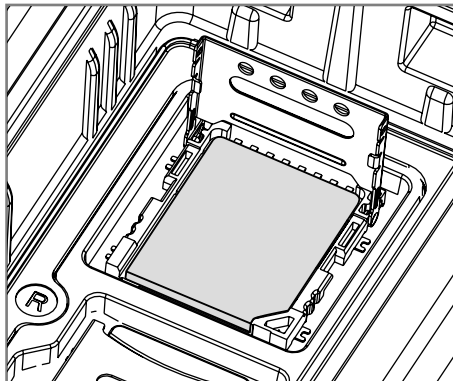

4. Close the holder down and slide it down to lock the holder.

Figure 5 Close SIM cardholder

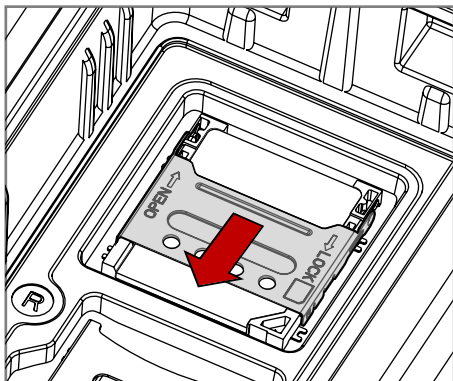

Getting Started

About SD card

To install the SD card,

1. Remove the battery while pressing the battery release button.
2. Gently slide the cardholder down, and swing upwards to open the holder.

Figure 6 Open SD cardholder

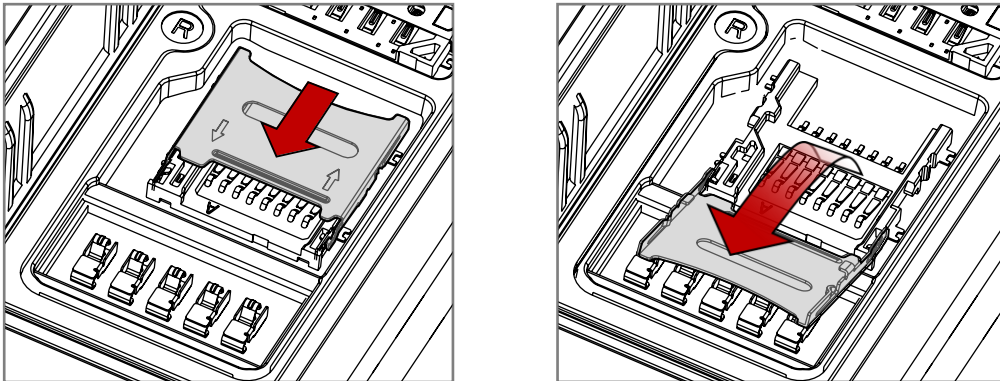

3. Put the card facing down the gold contact in the correct orientation.

Figure 7 Place SD card

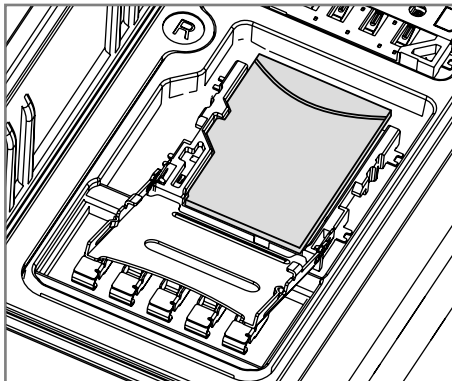

4. Put the holder down and slide it up to lock the holder.

Figure 8 Close SD cardholder

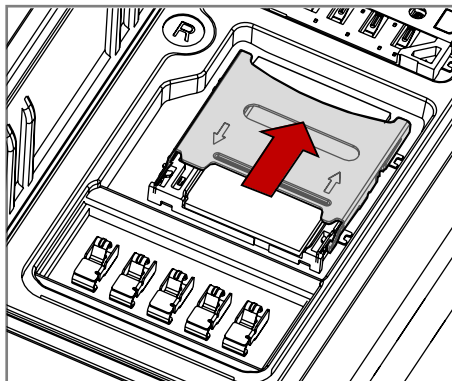

Getting Started

Install & Remove Battery

Install the battery



Caution: Make sure the SIM and SD cardholders are completely closed before installing the battery.

It may damage the device if you force to install the battery while the cardholders are not closed.

1. Align the battery release button to the bottom side of the device.
2. Insert the battery from the top side of the device.

Figure 9 Insert battery

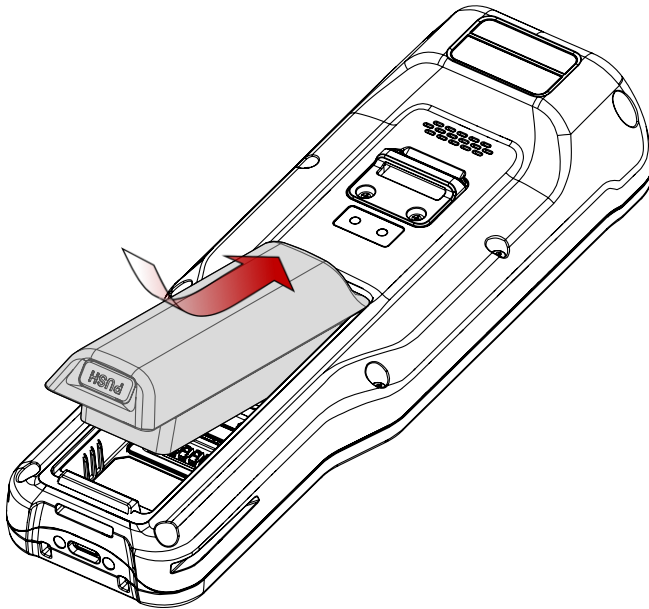

3. Push the battery down until it clicks, and check if the battery is firmly engaged.

Getting Started

Remove the battery

To remove the battery, pull up the bottom side of the battery while pressing the battery release button.

Figure 10 Remove battery

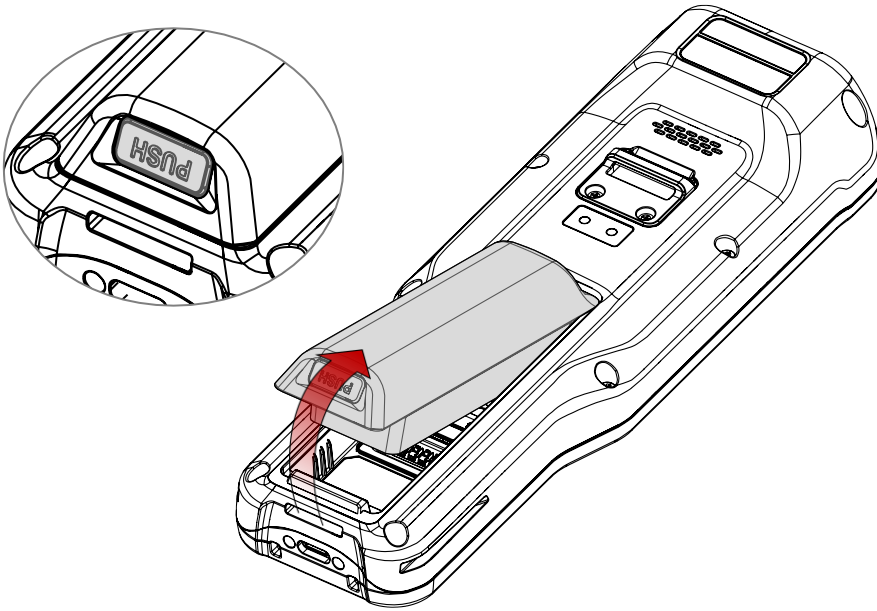

Battery Hot Swap

PM351 supports the Battery hot swap mode which allows you to replace the battery without turning off the device.

When the battery is removed from the device, the display turns off and the device enters Hot swap mode (Red LED will be turned on). In How swap mode, data is retained about 5 minutes.

Once you replace the battery to a new one, the device will come back to normal operation mode without booting process.

Getting Started

Charge the device

Before using PM351, charge the device enough to use. PM351 can be charged with power adapter or charging cradle.



Caution: Always use an original charger and cable from Point Mobile. Other chargers and cables may damage PM351. Also, make sure the charger and cables are not wet. Follow the [battery safety Information](#) for safety of using the battery.

Battery specification

- Capacity: 4,800mAh / 3.63V
- Rechargeable & Removable battery

Smart Charging

PM351 supports three charging modes to provide optimal battery performance for your work. Each mode controls the charging current or the maximum charging level to meet the needs.

When the device is charged to the maximum charging level, the device turns to a fully charged state (Power LED lights green. Refer to [LED indicator](#)).

- **Normal mode (Default)**
 - Standard charging mode
 - Maximum charging level: 100%
- **Life-X mode**
 - limits the maximum charging level to extend the battery lifetime.
 - Maximum charging level: around 80%
- **Fast charging mode**
 - Charges PM351 faster than the other modes.
 - Maximum charging level: 100%

Getting Started

To set smart charging mode, go to **Settings**  > **Battery**  > **Smart Charging** or **EmKit**  > **EmSettings**  > **Smart Charging**.

Figure 11 Smart charging

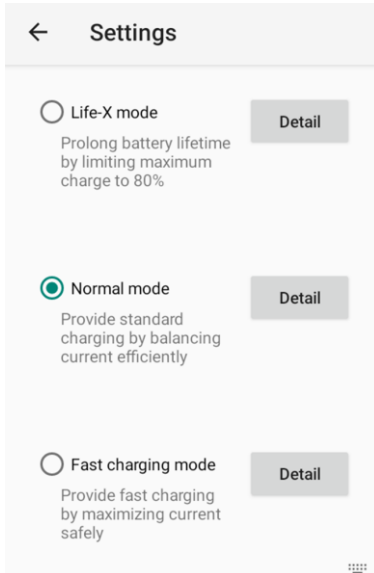

Find detail information of each mode in **Detail** and select the desired mode.

Getting Started

Charge with power adapter

1. Assemble the country plug, power adapter and USB type C cable.
2. Connect the cable to the USB connector of PM351.
3. Provide power by plugging the power adapter to the wall socket.

Figure 12 Charge PM351 with power adapter

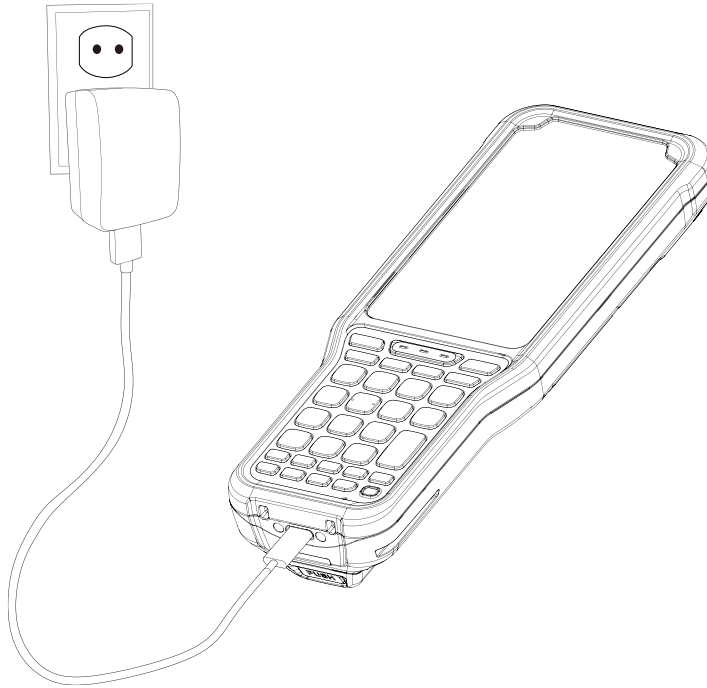

Getting Started

Charging Cradle

There are three types of charging cradle for PM351. Single slot cradle (SSC), 2 slot cradle (2SC), 4 slot battery cradle (4SBC). The cradles are sold separately.

For more detail of each cradle, refer to [Accessories](#) chapter.

Single Slot Cradle (SSC)

SSC provides one PM351 charging slot and one PM351 battery charging slot.

2 slot cradle (2SC)

2SC provides two PM351 charging slots. 2SC can be connected up to 3 pieces for more charging slots (Share cradle: 2SC ~ 6SC).

4 slot battery cradle (4SBC)







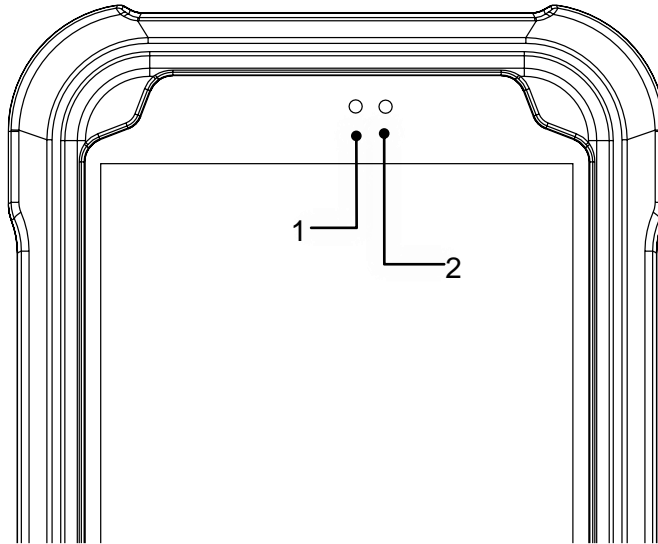

4SBC can charge up to 4 pieces of PM351 batteries at the same time.

Getting Started

LED Indicator

Figure 13 LED Indicators



No	Indicator	Status	Indication
1	Power LED	 Solid green	Device is completely charged
		 Solid red	Device is charging / Battery is low
		 Blinking red	Charging temperature is out of normal range / Battery is very low
		 Alternately blinking red & green	Cannot recognize the battery
2	Notification LED	 Solid red	Device entered Hot swap mode
		 Blinking blue	Notification existing
		 Red flash	Barcode reading failed
		 Blue flash	Barcode reading success

Getting Started

Turn on & off Device

To turn on the device,

- Press and hold the power button on the keypad until **SMART BEYOND RUGGED** logo displays on the screen.

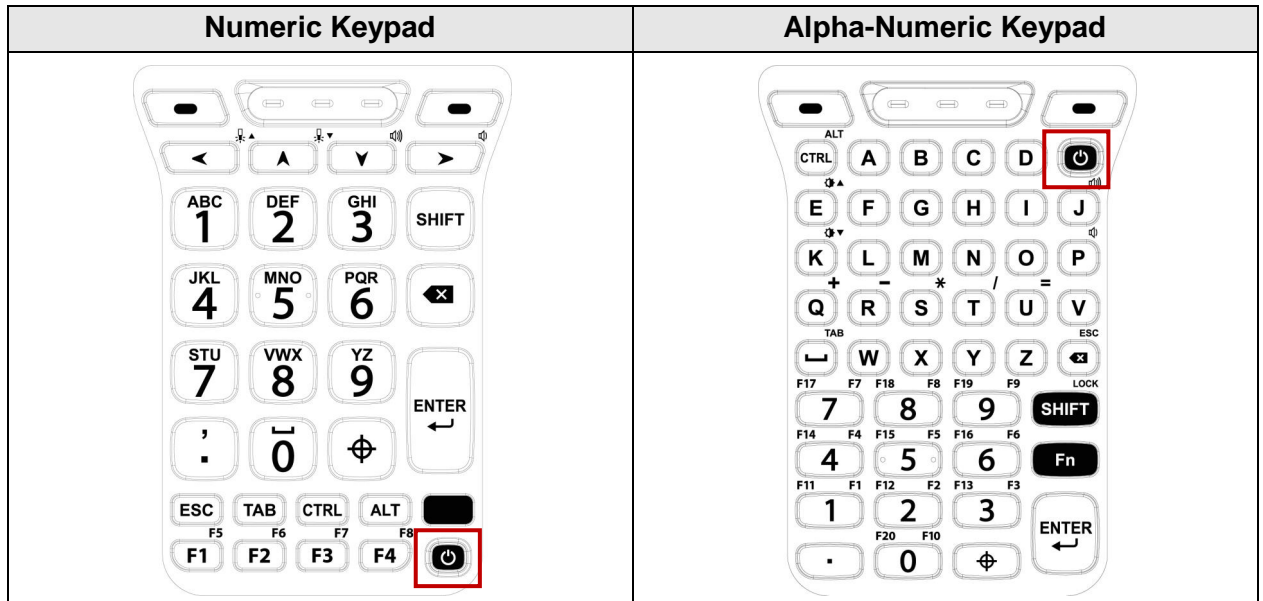

To turn off the device,

- Press and hold the power button when the display is on until the power menu is shown. Then, tap **Power off**.

Figure 14 Power menu - Power off





Getting Started

Use a Touch Screen

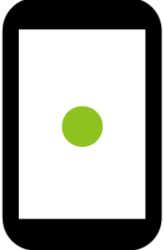
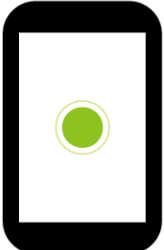
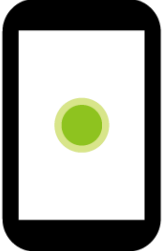
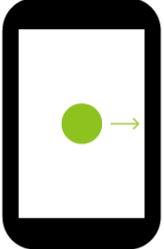
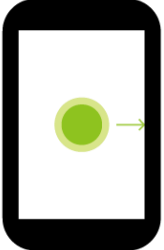
Controlling the touch screen

Gesture	Description
	<p>Tap One-finger press</p>
	<p>Double tap One-finger press, lift, one-finger press, lift for zoom in action</p>
	<p>Long-press One-finger press, wait, lift for select action</p>
	<p>Drag, Swipe, or Fling One-finger press, move, lift for scroll or tilt action</p>
	<p>Long-press drag One-finger press, wait, move, lift for pick up and move, or select multiple items action</p>

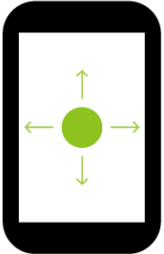
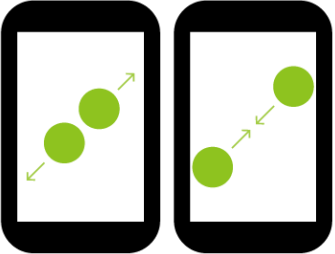
Getting Started

Action	Description
	Scroll Vertical or horizontal swipe in a single direction
	Pinch Open & Close Two-finger press, move outwards and inwards, lift for zoom in / out action
	Rotate When PM351 is turning sideways, screen orientation is changing

Getting Started

System navigation

Navigation bar (Software button)

The navigation bar is enabled as a default, and it is located at the bottom of the screen. The app overview button, home button, and back button are placed on the bar in order.

Figure 15 Navigation bar

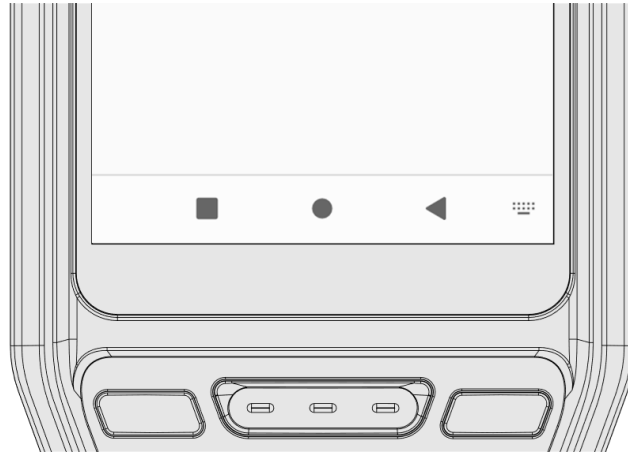



Shape	Button	Function
■	Recent apps button	Tap to see the recently used app list.
●	Home button	Tap to go to home screen. Long-press to launch the Google Assistant.
◀	Back button	Tap to go back to previous screen.

Getting Started

Gesture Navigation

If you are unfamiliar with the navigation bar or you want to see the screen with a wider screen, hide the navigation bar. The functions provided by the software buttons on the navigation bar can be used by using specific gestures.

To hide the navigation bar, navigate to **Setting**  > **System**  > **Gesture** > **System navigation** and change the setting to **Gesture navigation**. Then, the navigation bar will be hidden.

 **Note:** To use the navigation bar again, change the setting to **3-button navigation**.

Figure 16 Gesture navigation



Find the gestures and matched function in the table below.

Function	Gesture
Open recent apps screen	Swipe up from the bottom of the screen, hold, then release.
Go to home screen	Swipe up from the center-bottom of the screen.
Back to previous screen	Swipe from the left or right edge of the screen.
Launch Google Assistant	Swipe up from either the left-bottom or right-bottom.

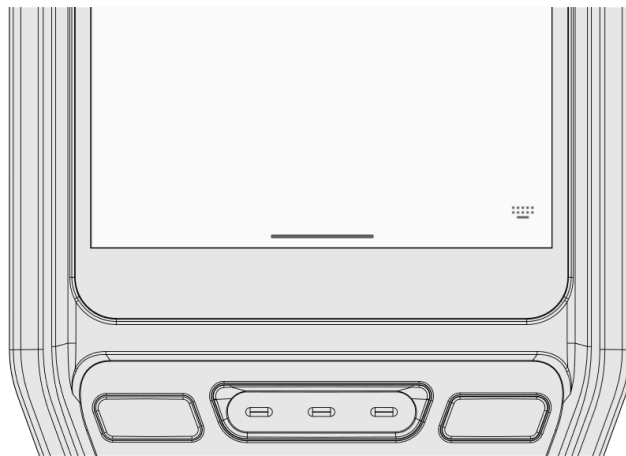
Learning the Basics

Setup Wizard

When PM351 starts very first time or boot after factory reset, Setup Wizard is launched. Following the steps on the screen, set system language, Google account, Wi-Fi connection and copy the data, etc.

Some settings can be skipped, but there may be some restrictions on the use of the system.

Figure 17 Setup Wizard (main)

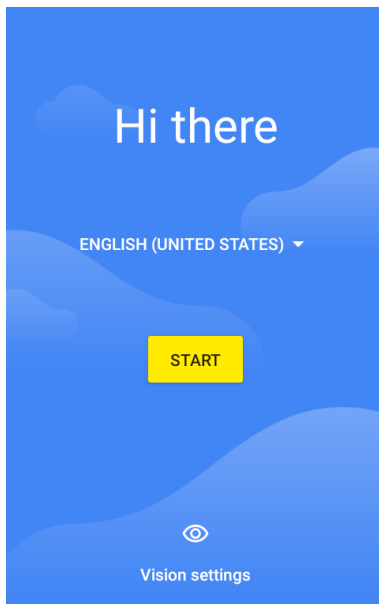
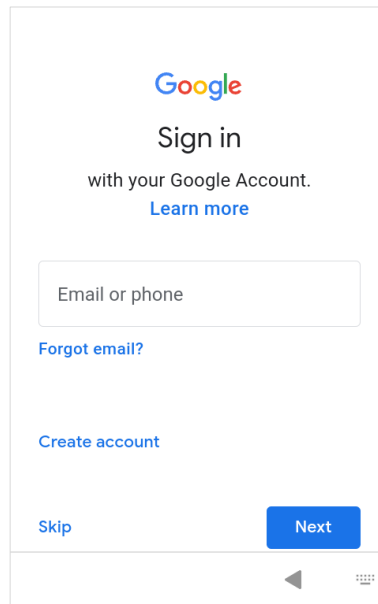

Figure 18 Setup Wizard (Google account)



Learning the Basics

Home Screen

Home screen is a screen displayed after Setup Wizard or pressing the Home button.

Figure 19 Home Screen

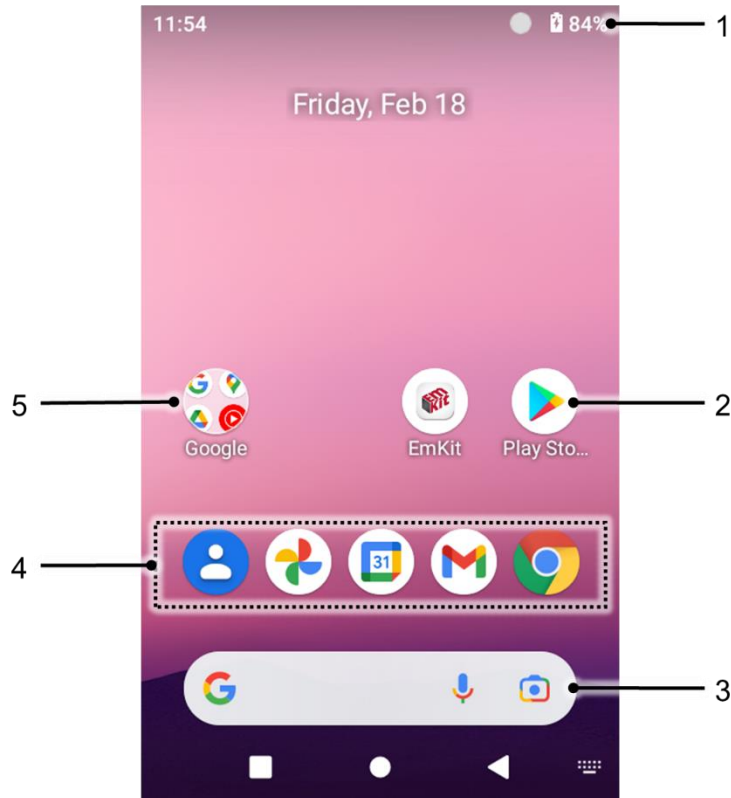

















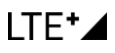















No	Item	Description
1	Status bar	Indicates device status and notification.
2	App	Tap to run the application Long-press to see the application's options
3	Google search	Search an item with Google
4	Favorites tray	Place the frequently used apps
5	App folder	Apps are organized in the folder. Tap to open the App folder

Learning the Basics

Status bar









Time, status icons, and notification icons are on the Status bar.

Status icons

Icon	Description	Icon	Description
	LTE connected		Strong signal
	3G connected		Weak signal
	EDGE connected		Connection issue
	LTE+ (LTE CA) connected		Data disabled
	Airplane mode		No data connection
	Hotspot enabled		Connected to a Bluetooth device
	Connected to a Wi-Fi network		Wi-Fi data communication
	Battery is full		Battery is low
	Battery is critical low		Cannot recognize battery
	Battery is charging		Alarm is set
	Location service turned on		Vibrate mode
	Scanner turned on		Scanner turned on, but trigger turned off
	Numeric input mode		Lowercase alphabet input mode
	Uppercase alphabet input mode (Temporary)		Uppercase alphabet input mode (Fixed)
	Functions input mode (Temporary)		Functions input mode (Fixed)
	CTRL functions mode		ALT functions mode

Learning the Basics

Notification icons

Icon	Description	Icon	Description
	New Email		Connected to VPN network
	Upcoming event		Other input method available
	File uploaded		File downloaded
	File copied		OTG device connected
	There are more notifications		

Notification panel

Notification panel displays a list of all notifications. Tap a notification to respond.

To open the Notification panel, drag the Status bar down. To close the panel, swipe it up.

Figure 20 Notification panel

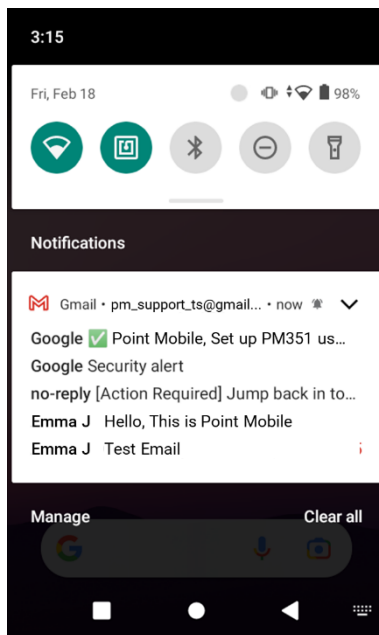

Learning the Basics

Quick setting panel

Quick setting panel contains some frequently used settings such as Wi-Fi, Bluetooth, etc.

To use the Quick setting panel,

1. Open the Notification panel.
2. Drag down the Notification panel.
3. Tap a setting icon to enable / disable the setting or long-press an icon to see more detail.

Figure 21 Quick setting panel

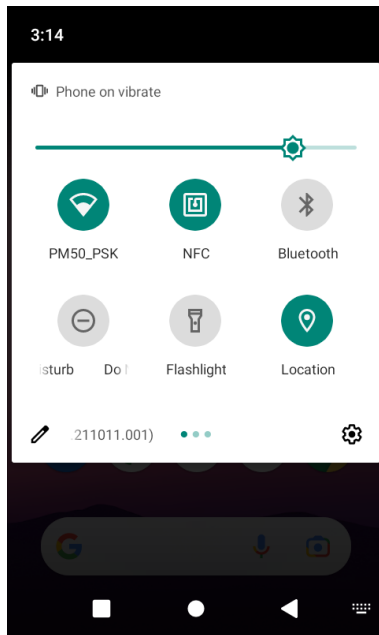

To edit the configuration of Quick setting panel,

1. Tap  on the bottom of the panel.
2. By long-press and dragging the icon, customize the configuration of the panel.

Learning the Basics

Apps & Widget

App folder

To create the app folder, long-press an app icon and drag it to another app icon.

Figure 22 Create app folder

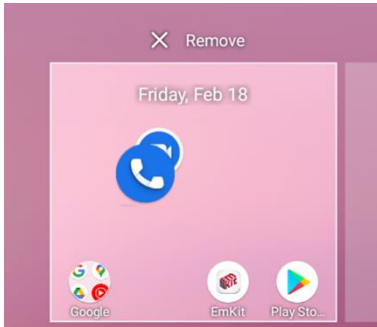

To change the folder name, tap the **Edit Name** and input a new name.

Figure 23 Change app folder name

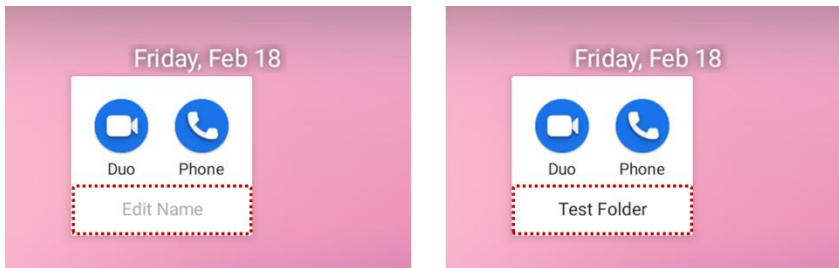

Learning the Basics

App drawer

All installed apps are listed alphabetically in App drawer.

- To open the App drawer, swipe up the Home screen.
- To close the App drawer, swipe down the Home screen.

Figure 24 App drawer

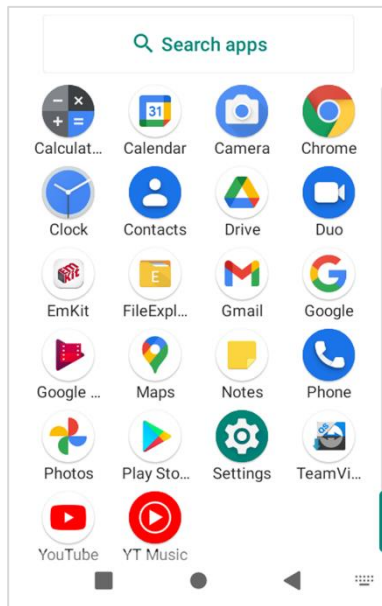

Favorites tray

To organize an app in the Favorites tray,

1. Long-press an app icon from the App drawer. Then, drag it slightly until the Home screen is shown.
2. Place the app icon in the Favorites tray.

Figure 25 Add an app to Favorites tray



Learning the Basics

Organize app in Home screen

To organize an app in the Home screen,

1. Long-press an app icon from the App drawer. Then, drag it slightly until the Home screen is shown.
2. Place the app icon where you want.

(To cancel to place the app, drag it to **Cancel** area and release.)

Figure 26 Place app in Home screen

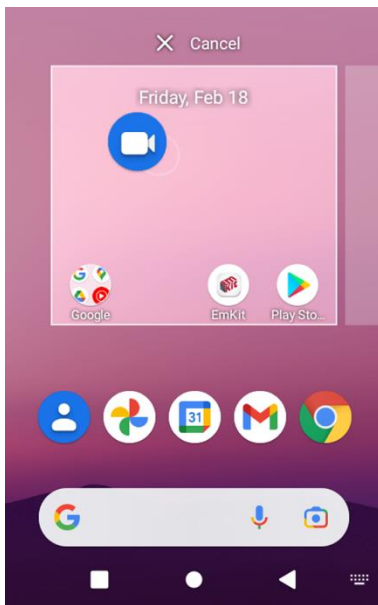

Learning the Basics

Widget

To add a widget in the Home screen,

1. Long-press the empty space of the Home screen.
2. In three menus, select **Widgets**.

Figure 27 Widget menus

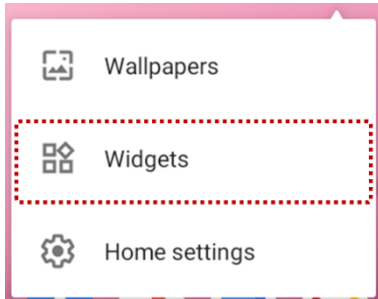

3. Among the list, tap and hold a widget you want to add.
4. Place the widget to the Home screen by dragging.

i **Note:** To remove an app or a widget from the Home screen, long-press and drag it to **Remove** area.

Figure 28 Remove from Home screen

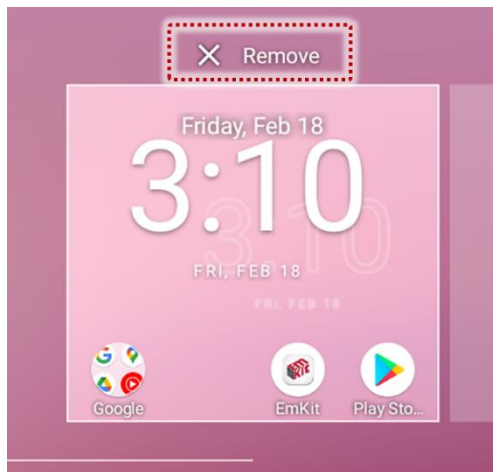

Learning the Basics

MTP Connection with PC

To transfer the files with a PC, connect the device to the PC via USB cable first.

1. Drag down Status bar and tap **Android System** notification to change USB preference option.

Figure 29 USB connection notification

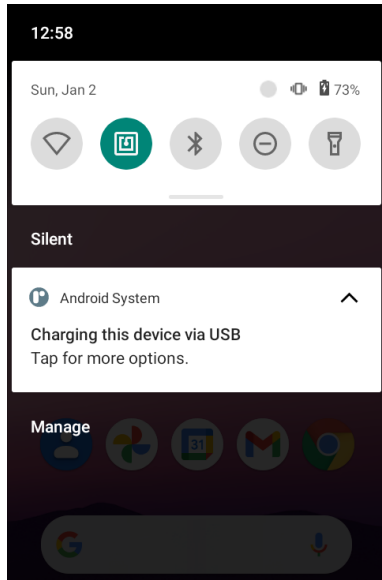

2. Change the option to **File Transfer** from **No data transfer**.

Figure 30 USB Preferences

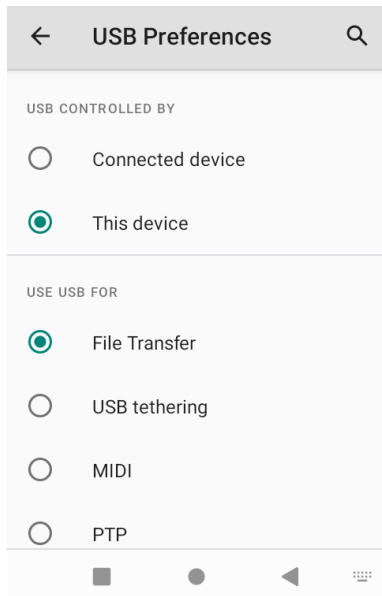

Learning the Basics

3. Now PC can recognize the connected device. Find PM351 device from file explorer of the PC.

Figure 31 File explorer on PC

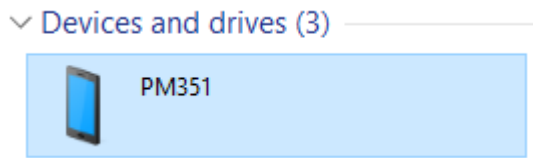

Manage the Files

Figure 32 FileExplorer main screen

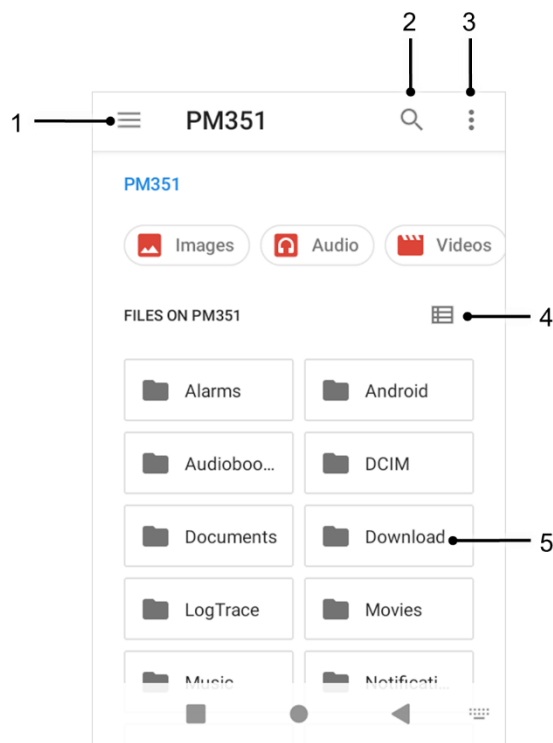

No	Description
1	Select media file type or storage
2	Search a file
3	Open the advanced option – Create a new window or folder, Select all files and folders, etc.
4	Change the view of file list
5	Tap a file or folder to open. Or long-press a file or folder to select

Learning the Basics

Long-press a file (folder) or tap the icon which is located beside of file name to select the file (folder).

Figure 33 FileExplorer screen when file selected

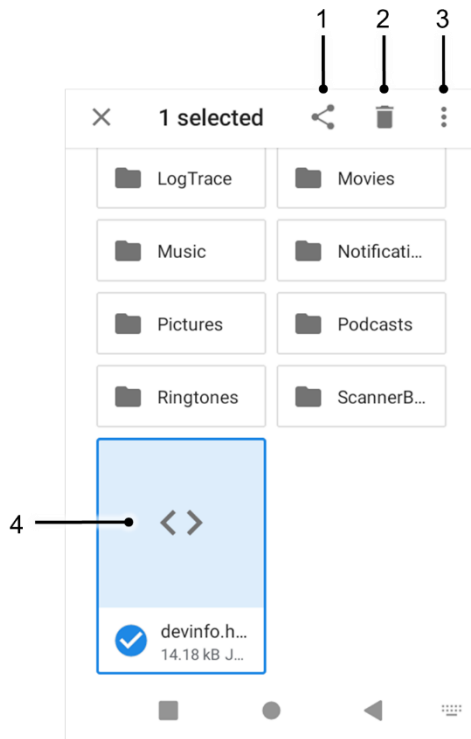

No	Description
1	Share the file via Bluetooth / Gmail / Google Drive, etc. Sharing is possible only with files
2	Delete the files or folders
3	Open the advanced option <ul style="list-style-type: none"> • Open with: Select which app to open the file • Sort by...: Sort the list by file name, size, type, etc. • Select all: Select all files and folders • Copy / Move to: Copy or move the file to a new location • Compress: Create Zip file with the selected files or folders • Rename: Rename the file or folder • Get info: Display the file information
4	Selected file or folder is highlighted

Learning the Basics

Lock the Screen

Protect the device from unauthorized personnel by setting up the screen lock.



1. Navigate to **Settings**  > **Security** .
2. Tap **Screen lock**.

Figure 34 Screen lock



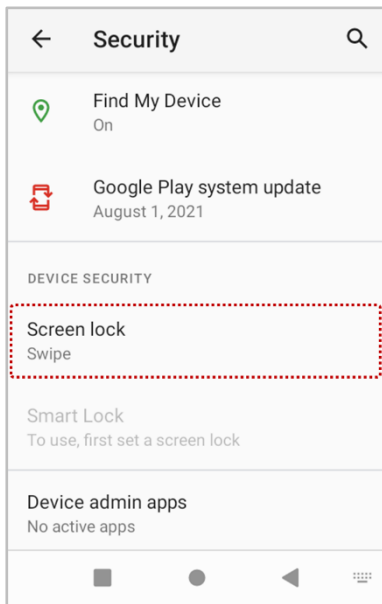

3. Choose a screen lock method.
 - None: Screen unlocks immediately
 - Swipe: Swipe the lock screen to unlock (Default)
 - Pattern: Draw a pattern to unlock
 - PIN: Input a PIN to unlock (At least 4 digits)
 - Password: Input a password to unlock (At least 4 characters)

Learning the Basics

Settings

There are two ways to go to **Settings**:

- Open the App drawer and tap **Settings** 
- Open the Quick setting panel and tap gear icon 

Adjust display brightness

To adjust the display brightness level,



- Open Quick setting panel and adjust display brightness bar
- Go to **Settings**  > **Display**  > **Brightness level**

Figure 35 Normal brightness level



Figure 36 High brightness level (higher than 80%)



Caution: Using high brightness levels for long periods may cause eye strain and increase battery consumption.

Adjust sound

To adjust sound volume, go to **Settings**  > **Sound**  and control the Media, Call, Alarm volume bars.

Figure 37 Volume bars

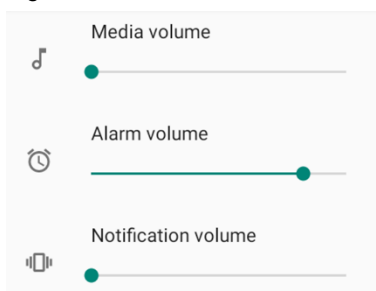

Caution: Using high volume levels for long periods may cause ear strain and increase battery consumption.

Learning the Basics

Use Keyboard Backlight

The buttons in the keypad may not be visible in the dark. For this inconvenience, PM351 have keyboard backlight so that you can find the proper keys easily.

To use the keyboard backlight,



1. Go to **Settings**  > **Display** 
2. Tap **Keyboard Backlight** switch.

Figure 38 Keyboard Backlight



You can adjust the brightness of the keyboard backlight with the keypad. See [Keypad – Functions](#). (Only available on Numeric Keypad.)

Learning the Basics

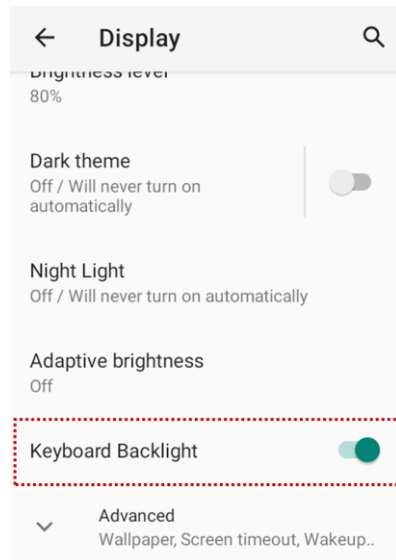
Adjust font size

If the font size of the screen is too small or too large, adjust the font size.

1. Go to **Settings**  > **Display** 
2. Tap **Advanced**
3. Tap **Font size**
4. Referring to the **Preview**, set the font size

Figure 39 Set font size

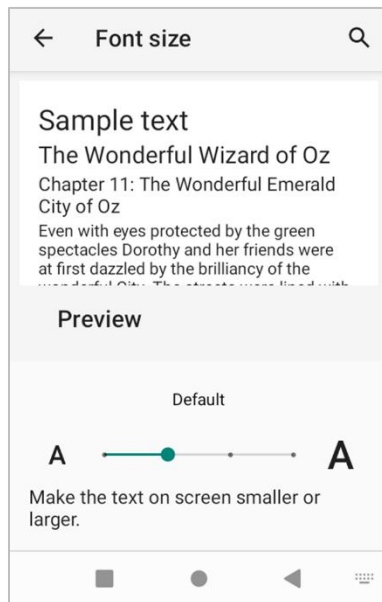



Using the Keypad

Keypad



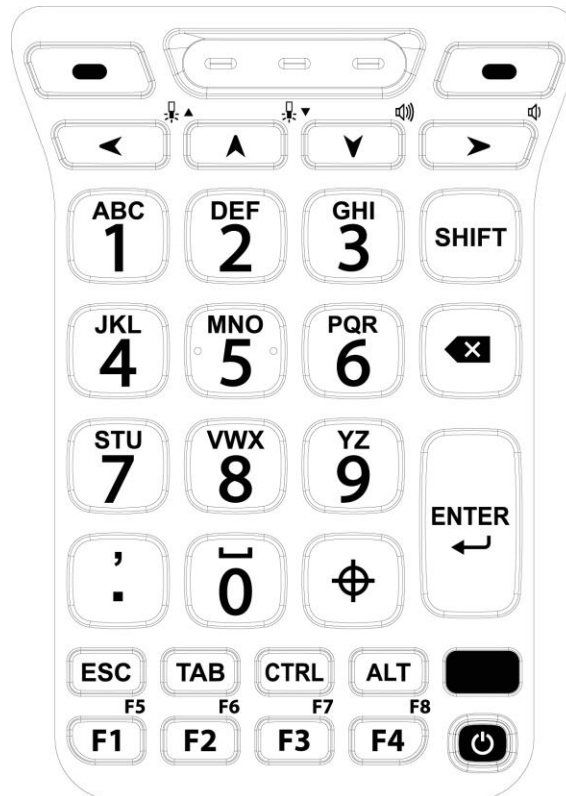

Numeric Keypad

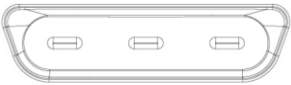
Figure 40 PM351 Numeric keypad



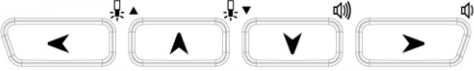









Key	Description
P1 / P2 SOFT_LEFT / SOFT_RIGHT 	Programmable keys, <ul style="list-style-type: none"> • P1 is the PTT key by default. • P2 is the Scan key by default.
Scan (Orange) SCANNER_F 	Scan the barcode







Using the Buttons

Key	Description									
<p>Left / Up / Down / Right <i>DPAD_LEFT / UP / DOWN / RIGHT</i></p> 	<p>In Numeric input mode</p> <ul style="list-style-type: none"> Moves left / up / down / right. <p>In Alphabet input mode</p> <ul style="list-style-type: none"> Controls keypad backlight brightness and volume. Refer to Functions section for more detail. 									
<p>Numeric 0~9 <i>0~9</i></p> 	<p>In Numeric input mode</p> <ul style="list-style-type: none"> Inputs 0 to 9. <p>In Alphabet input mode</p> <ul style="list-style-type: none"> Inputs alphabet in uppercase or lowercase, or blank space. 									
<p>Period / Decimal Point <i>PERIOD</i></p> 	<p>In Numeric input mode</p> <ul style="list-style-type: none"> Inputs a period <p>In Alphabet input mode</p> <ul style="list-style-type: none"> Inputs decimal point (comma) 									
<p>Symbol</p> 	<p>Press once</p> <ul style="list-style-type: none"> Inputs a symbol you set. By default, '~' will be inserted. <p>Press twice</p> <ul style="list-style-type: none"> Provides a 3x3 grid on the screen with nine additional symbols. Choose a symbol you want. <table border="1" data-bbox="846 1373 1117 1633"> <tbody> <tr> <td>✓ ~ <small>\u007e</small></td> <td>@ <small>\u0040</small></td> <td>- <small>\u002d</small></td> </tr> <tr> <td>£ <small>\u00a3</small></td> <td>: <small>\u003a</small></td> <td>€ <small>\u20ac</small></td> </tr> <tr> <td> <small>\u007c</small></td> <td>[<small>\u005b</small></td> <td>] <small>\u005d</small></td> </tr> </tbody> </table> <ul style="list-style-type: none"> You can change the configuration of the grid with Program buttons. Refer to Symbol grid. <p>Press three times</p> <ul style="list-style-type: none"> Hides the grid 	✓ ~ <small>\u007e</small>	@ <small>\u0040</small>	- <small>\u002d</small>	£ <small>\u00a3</small>	: <small>\u003a</small>	€ <small>\u20ac</small>	 <small>\u007c</small>	[<small>\u005b</small>] <small>\u005d</small>
✓ ~ <small>\u007e</small>	@ <small>\u0040</small>	- <small>\u002d</small>								
£ <small>\u00a3</small>	: <small>\u003a</small>	€ <small>\u20ac</small>								
 <small>\u007c</small>	[<small>\u005b</small>] <small>\u005d</small>								

Using the Buttons

Key	Description
Shift 	Toggle key for shift combination input mode. Press once <ul style="list-style-type: none"> Activates Shift combination input mode. The  icon appears on status bar. ex)  Press twice <ul style="list-style-type: none"> Maintains the Shift combination input mode. The  icon appears on status bar. ex)  Press three times <ul style="list-style-type: none"> Back to default input mode.
Backspace <i>DEL</i> 	Backspace function
Enter <i>ENTER</i> 	Enter function
ESC <i>ESCAPE</i> 	Escape function
TAB <i>TAB</i> 	Tab function
CTRL (Control) 	Activates the CTRL functions mode. The  icon appears on the status bar.

Using the Buttons



Key	Description
ALT 	Activates the ALT functions mode. The  icon appears on the status bar.
Alpha (Yellow) 	Toggle key for Alphabet input mode. The keycode or function shown on the keypad in yellow will be inputted in Alphabet input mode. Press once <ul style="list-style-type: none"> • Activates Alphabet input mode • The  icon appears on status bar Press twice <ul style="list-style-type: none"> • Back to default input mode
Function 1~4 (5~8) <i>F1~F8</i> 	In Numeric input mode <ul style="list-style-type: none"> • Executes the function mapped to F1 to F4 In Alphabet input mode <ul style="list-style-type: none"> • Executes the function mapped to F5 to F8
Power 	Turns on / off the device or screen

Using the Buttons



Alpha-Numeric Keypad

Figure 41 PM351 Alpha-Numeric keypad





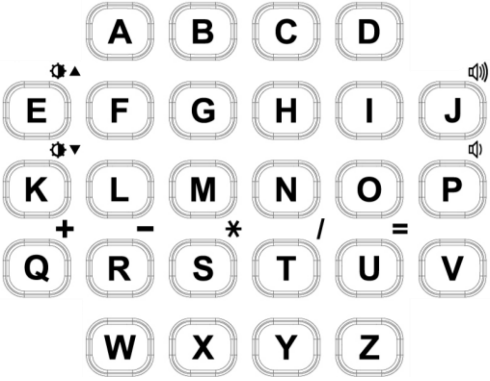
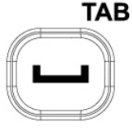
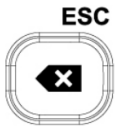

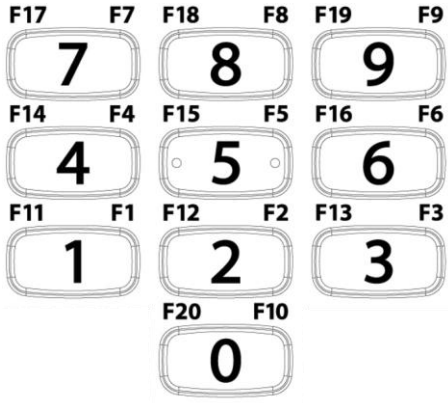



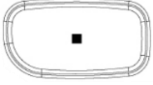

Key	Description
P1 / P2 SOFT_LEFT / SOFT_RIGHT 	Programmable keys, <ul style="list-style-type: none"> • P1 is the PTT key by default. • P2 is the Scan key by default.
Scan (Orange) SCANNER_F 	Scan the barcode
CTRL / ALT 	In Default input mode <ul style="list-style-type: none"> • Activates the CTRL functions mode. • The C^t icon appears on the status bar. In Functions input mode <ul style="list-style-type: none"> • Activates the ALT functions mode. • The A^t icon appears on the status bar.





Using the Buttons

Key	Description
<p>Alpha keys</p> 	<p>In Default input mode</p> <ul style="list-style-type: none"> Inputs alphabet in uppercase or lowercase. (Depends on whether shift combination mode is activated or not.) <p>In Functions input mode</p> <ul style="list-style-type: none"> Inputs some math symbols (Q~U) Controls screen brightness and volume. (E, J, K, P) (Refer to Functions section for more detail.)
<p>Space / TAB</p> <p>SPACE / TAB</p> 	<p>In Default input mode</p> <ul style="list-style-type: none"> Space function <p>In Functions input mode</p> <ul style="list-style-type: none"> Tab function
<p>Backspace / ESC</p> <p>DEL / ESCAPE</p> 	<p>In Default input mode</p> <ul style="list-style-type: none"> Backspace function <p>In Functions input mode</p> <ul style="list-style-type: none"> Escape function
<p>Power</p> 	<p>Turns on / off the device or screen</p>
<p>Numeric 0~9 / Function 1~20</p> <p>0~9 / F1~F20</p> 	<p>In Default input mode</p> <ul style="list-style-type: none"> Inputs 0 to 9. <p>In Functions input mode</p> <ul style="list-style-type: none"> Executes the function mapped to F1 to F10 <p>In Shift combination input mode</p> <ul style="list-style-type: none"> Executes the function mapped to F11 to F20

Using the Buttons

Key	Description									
Period <i>PERIOD</i> 	Inputs a period									
Symbol 	<p>Press once</p> <ul style="list-style-type: none"> Inputs a symbol you set. By default, '~' will be inserted. <p>Press twice</p> <ul style="list-style-type: none"> Provides a 3x3 grid on the screen with nine additional symbols. Choose a symbol you want. <table border="1" data-bbox="846 741 1117 999"> <tbody> <tr> <td> ~ <small>\u007e</small></td> <td>@ <small>\u0040</small></td> <td>- <small>\u002d</small></td> </tr> <tr> <td>£ <small>\u00a3</small></td> <td>: <small>\u003a</small></td> <td>€ <small>\u20ac</small></td> </tr> <tr> <td> <small>\u007c</small></td> <td>[<small>\u005b</small></td> <td>] <small>\u005d</small></td> </tr> </tbody> </table> <ul style="list-style-type: none"> You can change the configuration of the grid with Program buttons. Refer to Symbol grid. <p>Press three times</p> <ul style="list-style-type: none"> Hides the grid 	 ~ <small>\u007e</small>	@ <small>\u0040</small>	- <small>\u002d</small>	£ <small>\u00a3</small>	: <small>\u003a</small>	€ <small>\u20ac</small>	 <small>\u007c</small>	[<small>\u005b</small>] <small>\u005d</small>
 ~ <small>\u007e</small>	@ <small>\u0040</small>	- <small>\u002d</small>								
£ <small>\u00a3</small>	: <small>\u003a</small>	€ <small>\u20ac</small>								
 <small>\u007c</small>	[<small>\u005b</small>] <small>\u005d</small>								
Shift / Lock (Yellow) 	<p>Toggle key for Shift combination input mode. The functions shown on the keypad in yellow will be inputted in Shift combination input mode.</p> <p>Press once</p> <ul style="list-style-type: none"> Activates Shift combination input mode. The  icon appears on status bar. ex)  <p>Press twice</p> <ul style="list-style-type: none"> Maintains the Shift combination input mode. The  icon appears on status bar. ex)  <p>Press three times</p> <ul style="list-style-type: none"> Back to default input mode. 									







Using the Buttons

Key	Description
Fn (Blue) 	<p>Toggle key for functions input mode. The keycode or function shown on the keypad in blue will be inputted in functions input mode.</p> <p>Press once</p> <ul style="list-style-type: none"> • Activates Functions input mode. • The  icon appears on status bar. <p>Press twice</p> <ul style="list-style-type: none"> • Maintains the functions input mode. • The  icon appears on status bar. <p>Press three times</p> <ul style="list-style-type: none"> • Back to default input mode.
Enter ENTER 	Enter function

Using the Buttons

Use the Buttons

Functions

Function	Description	Numeric Keypad	Alpha-Numeric Keypad
	Volume down	Alpha + Right	Fn + P
	Volume up	Alpha + Down	Fn + J
	Display brightness down	-	Fn + K
	Display brightness up	-	Fn + E
	Keyboard backlight brightness down	Alpha + Up	-
	Keyboard backlight brightness up	Alpha + Left	-

Screenshot

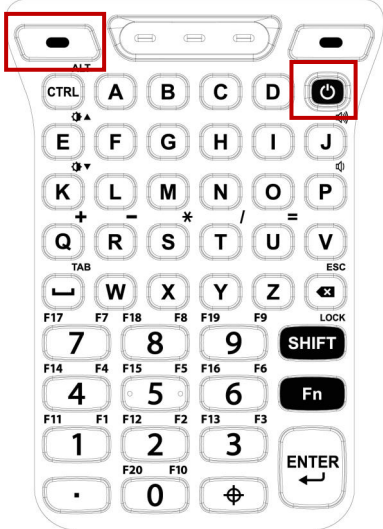
	Numeric	Alpha-Numeric
Key Combination	Power + P1 (SOFT_LEFT)	
Figure		

Using the Buttons

Program buttons

All buttons on the PM351 except power button can be optimized as you want. To map the button to other functions from default,

1. Navigate to **EmKit**  > **Program Buttons** 
2. Select a button from the list

Figure 42 Program buttons - button list

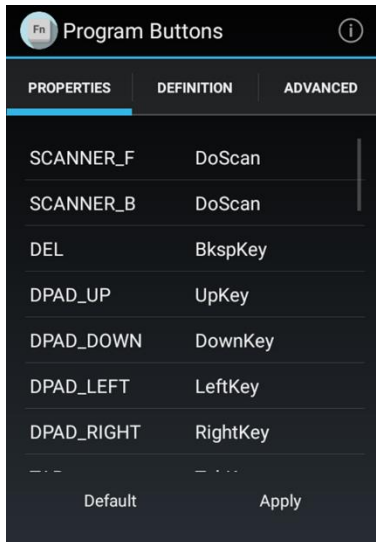

Find appropriate [keypad](#) chapter, and refer to the texts in *italic font* to find button code name.



Note:

- **SCANNER_B**: *Trigger button on the gun handle.*

3. Choose one function you want to remap.
4. Tap **OK**.
5. After changing all key mapping, tap **Apply** to save the changes.

Using the Buttons

Symbol grid

You can set the grid configuration of Symbols key in keypad with Program Buttons. To set the grid,

1. Navigate to **EmKit**  > **Program Buttons**  > **ADVANCED** tab.

Figure 43 Program buttons - symbol grid

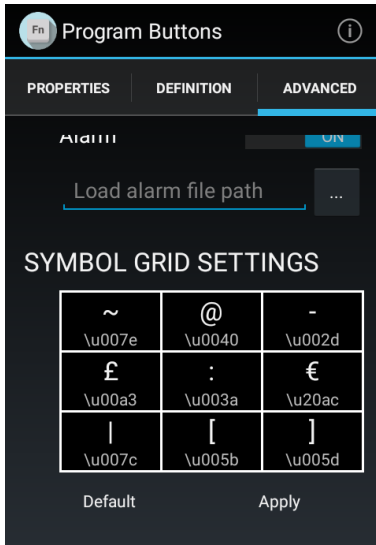

2. Tap a cell of the grid you want to change.
3. Input the Unicode of the desired symbol in the dialog.
4. Tap **OK**.
5. After setting up the symbol grid, tap Apply on the bottom to save the changes.

 **Note:** To find the Unicode, see [this page](#) of Wikipedia.

Camera

PM351 except SKU1 has a camera on the top of the device (next to the scanner). To use the camera, open App drawer and tap the Camera application .

Figure 44 is a main screen of Camera application, and Figure 45 is a screen that is displayed when you wipe the screen to right.

Figure 44 Camera main screen

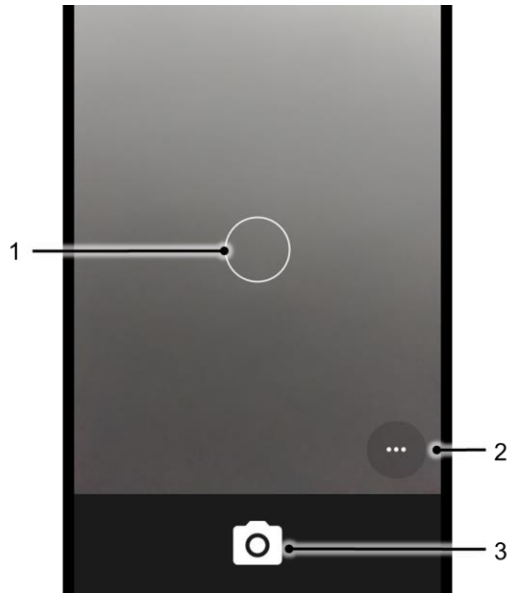
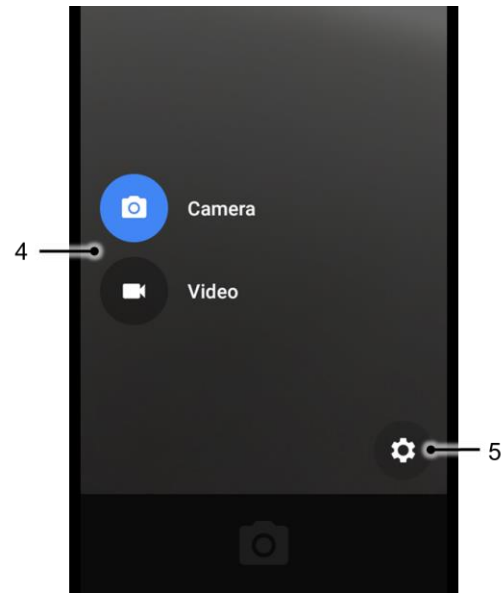





Figure 45 Camera mode change / setting screen



No	Name	Description
1	Focus zone	You can change the focusing area by touching the other area
2	Advanced camera option	 : Set timer  : Display the grid on the screen  : Set flash mode (Activate / Deactivate / Auto mode)
3	Shutter button	Take a picture or recode a video
4	Mode change button	Change the Camera or Video mode
5	Advanced camera setting	Set resolution & quality of picture Enable / Disable saving location and manual exposure

Scanner

Scanner is placed on the top of the PM351. Optimize the scanner settings for working environment and improve the efficiency.

Turn on / off the Scanner

The scanner is turned off by default. To turn on the scanner, follow the steps.



1. Go to **EmKit**  or **Settings**  and tap **ScanSettings**.
2. Tap toggle button to turn on/off the barcode scanner.
3. Check if the scanner icon  is placed on Status bar.

Figure 46 Turn on scanner



Scanner

ScanSettings

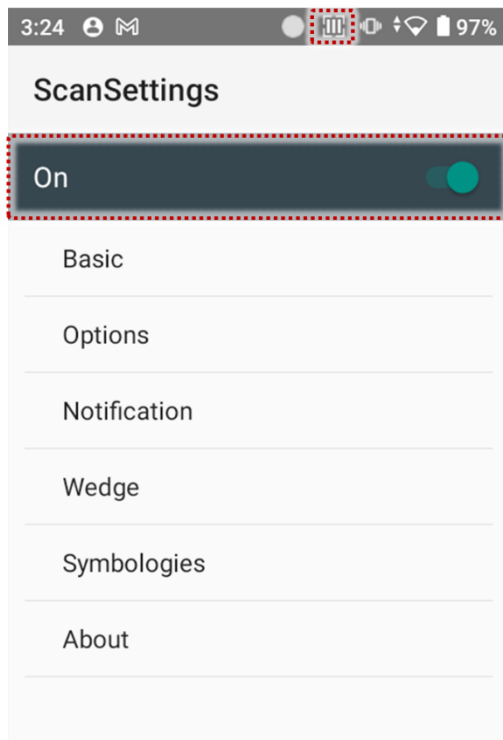
When the scanner is turned on, scanner setting menus will be displayed. **ScanSettings** consists of

- Basic
- Options
- Notification
- Wedge
- Symbologies
- About

Basic

Control the scanning options and wedge mode options.

1. Scanning

- Change the scanner's trigger timeout and set Auto scan & Continuous scan.
- Enable or disable the TouchScan, which is a software scanner button. Place a scan icon in any position and tap the icon to read a barcode.

Figure 47 ScanSettings - Basic

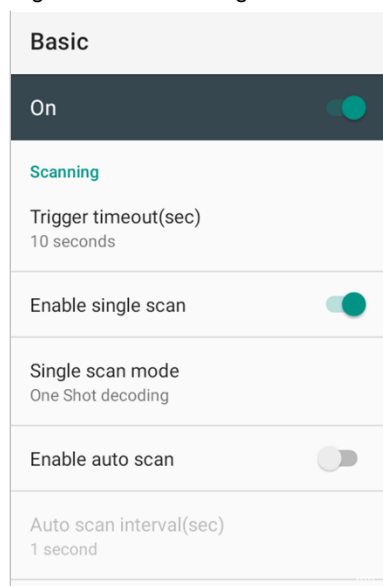
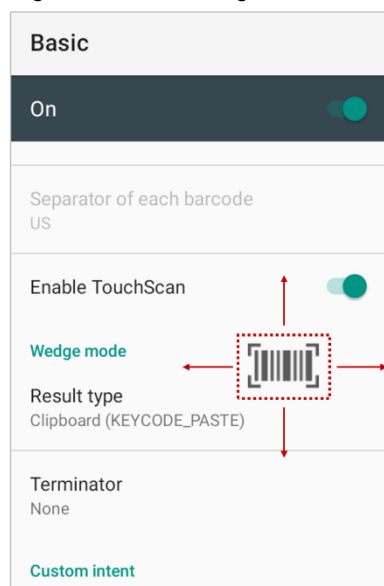

Figure 48 ScanSettings - TouchScan



Scanner

2. Wedge mode

- Change the result type of decoded data among the below list.
 - User Message
 - Keyboard Event
 - Clipboard (KEYCODE_PASTE)
 - Clipboard (Ctrl + V)
 - Intent Broadcast
 - Custom Intent
- Set Terminator as,
 - None
 - Space
 - Tab
 - LF
 - Tap & LF

Options

- Enable / Disable the center window, Aimer, Illumination.

Figure 49 ScanSettings - Options

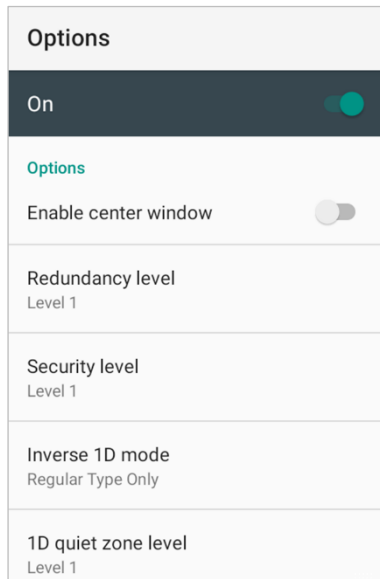

Scanner

Notification

Control the beep sound, LED and vibration option.

Figure 50 ScanSettings - Notification

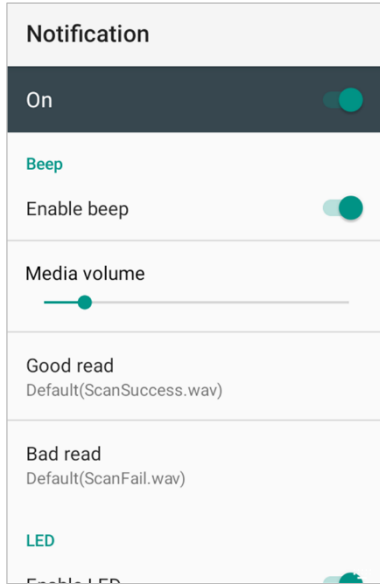

Scanner

Wedge

Set below items in Wedge settings

- Barcode ID
- AIM ID
- Group separator
- Prefix
- Suffix
- Character set
- Extended Wedge

Figure 51 ScanSettings - Wedge

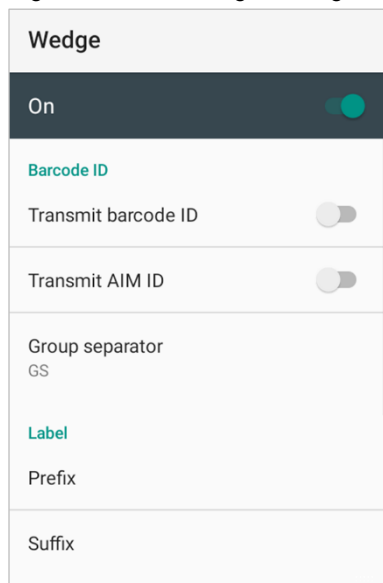

Scanner

Extended wedge

PM351 supports Extended wedge that allows to edit the decoded data. Tap **Enable extended wedge** toggle switch and then set a rule in **Configuration extended wedge**.

Figure 52 ScanSettings - Extended wedge

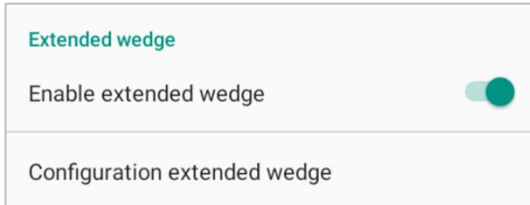

For example, make a rule that add a string “*Point Mobile*” at the start of decoded data whenever decoding CODE128.

1. Tap **Style** (1) and select **Condition** (2).

Figure 53 Extended wedge example_1

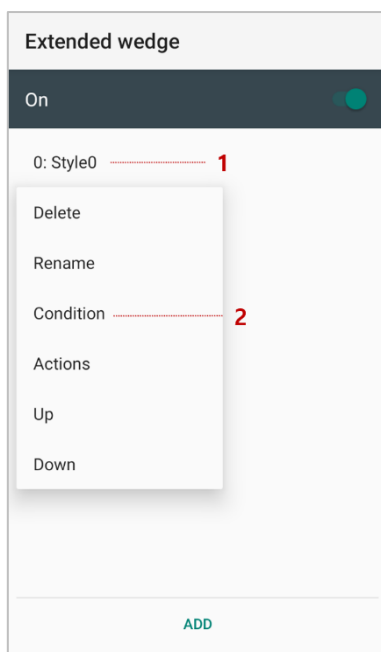

Scanner

2. Tap **Symbologies** and select **CODE128** among the symbologies.

Figure 54 Extended wedge example_2

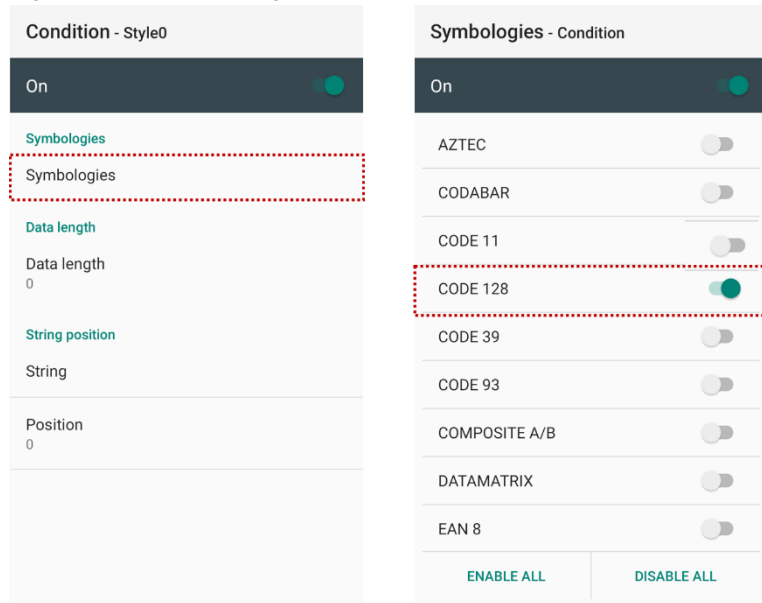

3. Tap **Style (1)** and select **Actions (2)**.

Figure 55 Extended wedge example_3

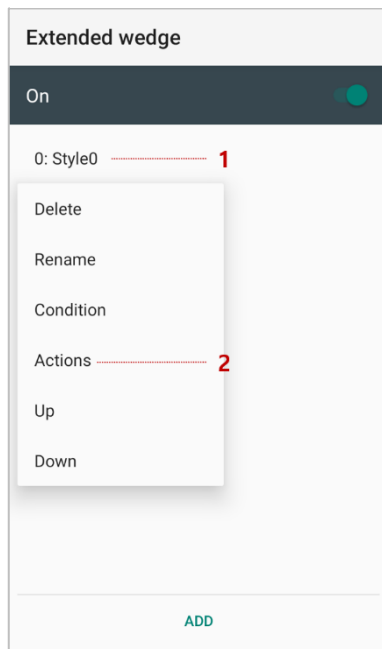

Scanner

4. Tap **ADD** and select **Move to start** to point the start of the decoded data.

Figure 56 Extended wedge example_4

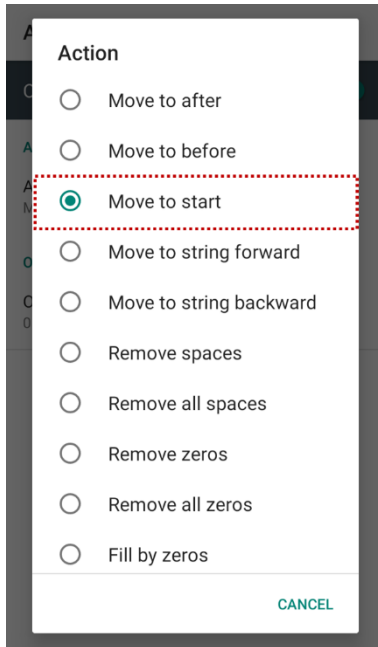

5. Add another action of which action type is Send string. Set value as "*Point Mobile*".

Figure 57 Extended wedge example_5

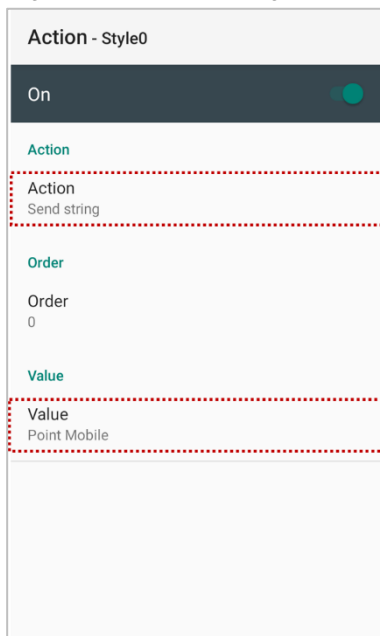

Scanner

6. "Point Mobile" string will be added to decoded CODE128 data.

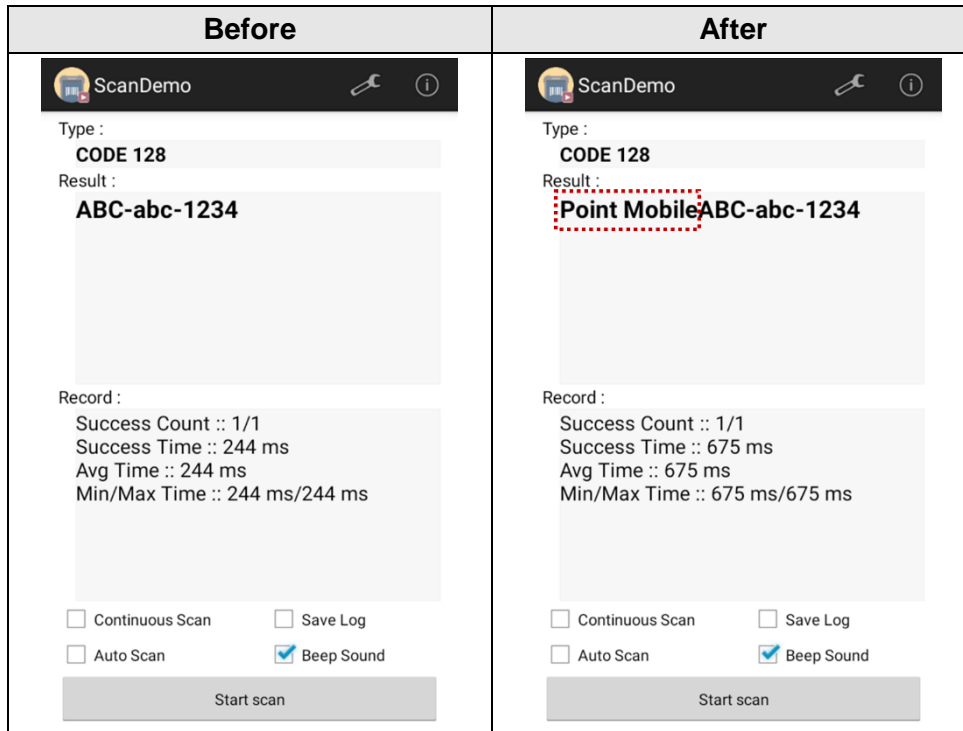

Scanner

Symbologies

Enable or disable the specific symbology or set detail options. By tapping each symbology name to access detail options.

Figure 58 ScanSettings - Symbologies

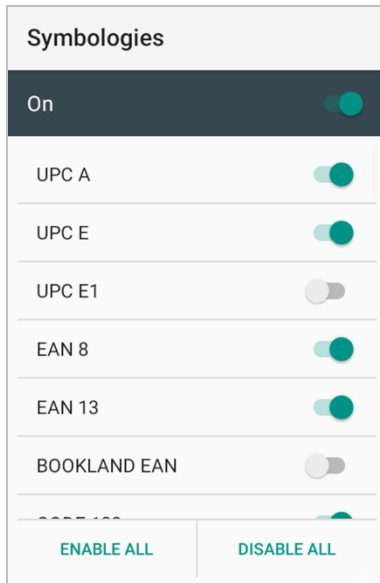

About

Find the scanner information or restore the scanner settings to default.

Figure 59 ScanSettings - About

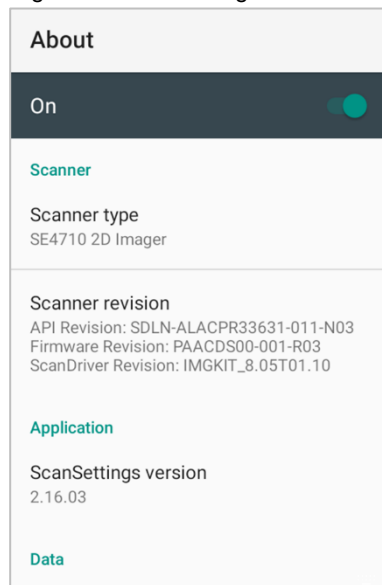

Scanner

Scan a Barcode

Point the scanner at the barcode and press the scan button on the keypad. If another button is set as scan trigger using Program buttons (Refer to [Use the Buttons – Program buttons](#)), it can trigger the scan action, too.

SE965 Scanner SKU (SKU1)

Aim the middle of the barcode so that the aimer is cover the entire barcode length.

Figure 60 Aiming barcode (SE965)



SE4100 Scanner SKU (SKU2, 6, 7)

Center the green dot aimer over the barcode. The entire barcode must be inside the illumination square.

Figure 61 Aiming barcode (SE4100)



SE4710 Scanner SKU (SKU3, 4, 5)

Center the red dot aimer over the barcode. The entire barcode must be inside the illumination square.

Figure 62 Aiming barcode (SE4710)



Scanner

ScanDemo

Using ScanDemo app, demonstrate scanning feature.



1. Execute **EmKit**  > **ScanDemo** .
2. Scan a barcode by pressing the scan button on the device or tapping **Start scan** button on the screen.
3. Find scan result

Figure 63 ScanDemo



Wireless

Mobile Network (LTE SKU Only)

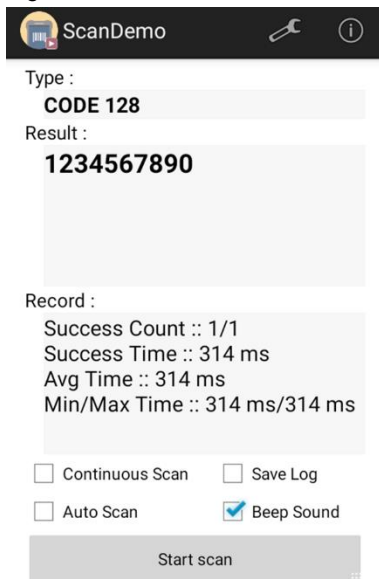
Note: Mobile network is supported on PM351 LTE SKU (SKU5, SKU7) only. Check your PM351 supports LTE.

To connect mobile network, SIM card is required. Insert SIM card into PM351 first referring [Install SIM & SD card](#).

After inserting the SIM card, reboot the device. When network is connected, a network icon will be appeared on the status bar.

Figure 64 Mobile network icon

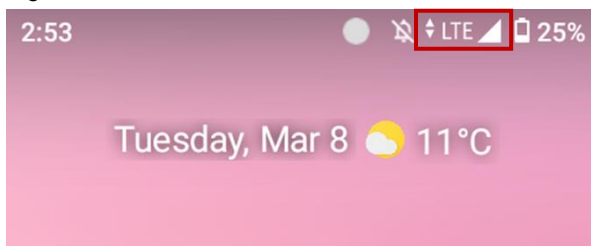

Find network information and adjust the network settings in **Settings**  > **Network & internet** .

Figure 65 Mobile network setting

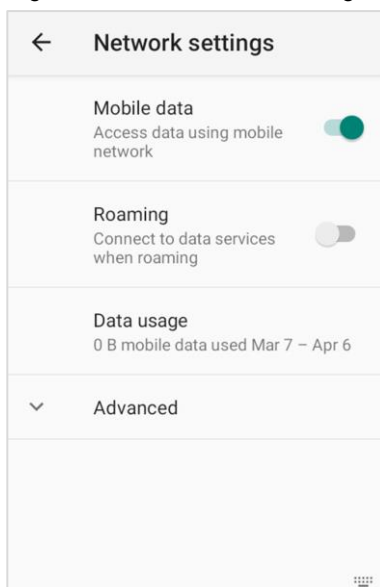
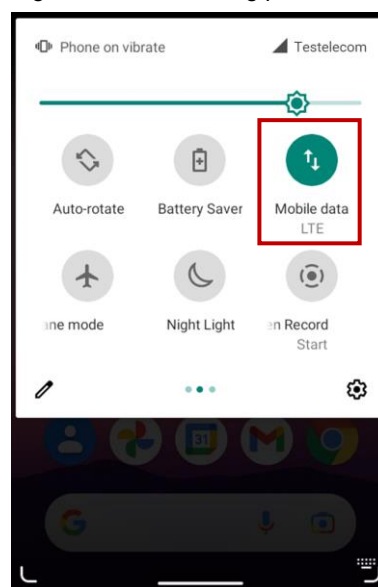

Figure 66 Quick setting panel - mobile network



This setting menu can also be accessed by long-press the Mobile data icon in Quick setting panel.

Wireless

Wi-Fi

To turn on and connect a Wi-Fi,



1. Go to **Settings**  > **Network & internet**  > **Wi-Fi**.
2. Tap toggle button to enable Wi-Fi.
3. Device searches for nearby Wi-Fi signals and lists them in order of signal strength.
4. Select a Wi-Fi SSID to connect.
5. The message **Connected** under the SSID means the device complete to connect to the Wi-Fi.

Figure 67 Wi-Fi connected



Note: There are Open Wi-Fi network and Secured Wi-Fi network. You can tell those apart by lock icon (🔒) in the nearby Wi-Fi list.

To connect the secured Wi-Fi network, you need to enter the password.

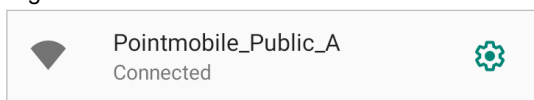
Figure 68 Open Wi-Fi Network

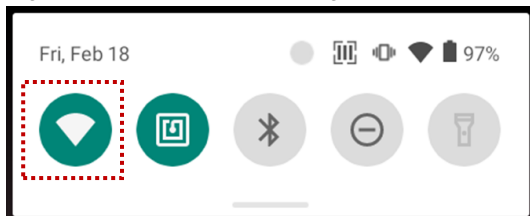

Figure 69 Secured Wi-Fi Network



If there is a saved Wi-Fi network, simply turn on the Wi-Fi through the Quick setting panel. The saved network will be connected automatically.

Figure 70 Wi-Fi in Quick setting panel



Wireless

Bluetooth

Turn on / off

Bluetooth is turned off as default. There are two ways to turn on the Bluetooth,

- Open quick setting panel and enable Bluetooth 

Figure 71 Bluetooth in Quick setting panel



- Go to **Settings**  > **Connected devices**  > **Pair new device**

Pair and Connect

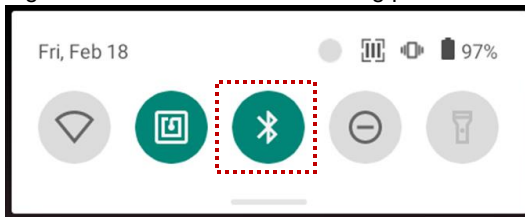
Bluetooth is turned off as default. To turn on the Bluetooth and connect with a new device,



1. Go to **Settings**  > **Connected devices** .
2. Tap **Pair new device**.
(Bluetooth will be turned on automatically)
3. Select the device you want to pair among **Available devices** list.

Figure 72 Bluetooth available devices



4. Follow instructions on the screen (Pairing code or pairing confirmation dialog) and tap **PAIR**.

Wireless

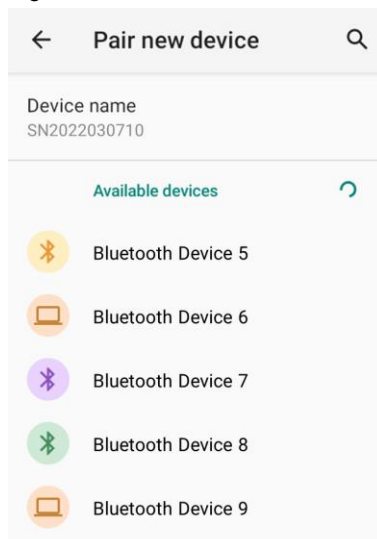
5. When the connection is succeeded, the connected device name is listed in **CURRENTLY CONNECTED**

Figure 73 Bluetooth currently connected

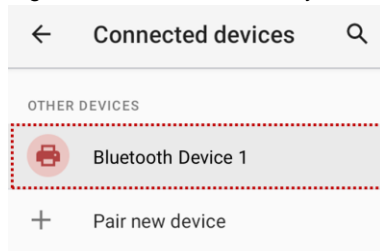

To connect a device previously connected, select the device name from the **PREVIOUSLY CONNECTED DEVICES** list.

Figure 74 Previously connected devices

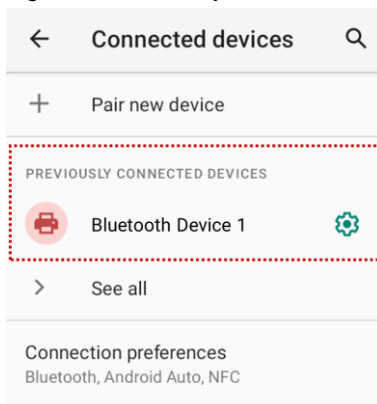

Unpair and Disconnect

To unpair the device, select the name of the device you want to unpair from **CURRENTLY CONNECTED** list and tap **FORGET** .

Or tap **DISCONNECT**  to disconnect only and not unpair.

Figure 75 Forget device



Wireless

Change the Bluetooth device details

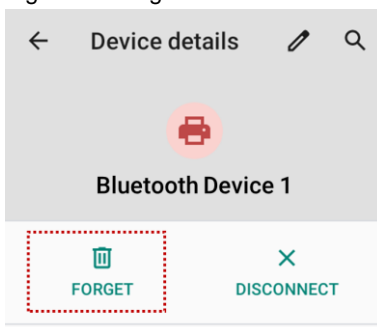
Select a device name from **CURRENTLY CONNECTED** or tap  icon next to the device name from **PREVIOUSLY CONNECTED DEVICES** list.

If no devices are listed under the **PREVIOUSLY CONNECTED DEVICES**, tap **See all**.

Figure 76 Bluetooth device detail

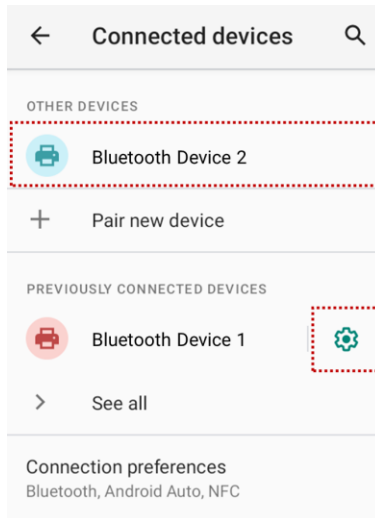

- To change the device's name, tap  on the top of the screen
- Turn other settings on or off (Available on some devices)

Wireless

NFC

PM351's NFC antenna is located on the rear-top side of the device. Bring the NFC tag close to the antenna location as Figure 78.

NFC feature is enabled by default. But if NFC does not work, make sure the NFC  is enabled from the Quick setting panel.

Figure 77 PM351 NFC tapping area

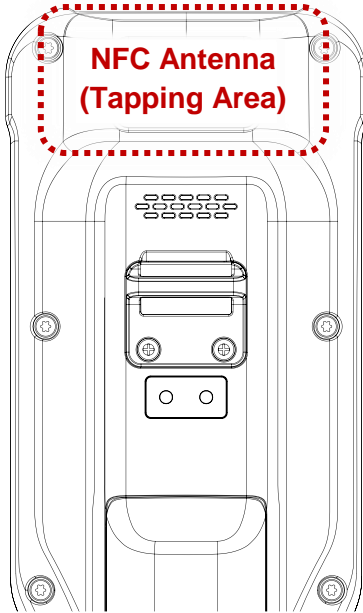

Figure 78 NFC tapping



System Maintenance

System Information

There are two ways for checking system information, on settings and on EmKit.

On Settings

Go to **Settings**  > **About phone** . Following information can be found.

- Device name
- Emergency information
- Legal information & Certificates
- Model & SIM status
- Hostname
- Android version
- IMEI
- IP address
- Wi-Fi MAC address
- Bluetooth address
- Build number

On EmKit

Go to **EmKit**  > **System Information** . Following information can be found.

- Processor information
- Version information (Android version, OS image version, SDK version, etc.)
- Manufacturer information (Serial number, Part number, etc.)
- Device information (Scanner, Camera, Audio, Display, etc.)
- Battery information (Battery charging status, etc.)
- App version information (Version of EmKit apps)

System Maintenance

Check Device Health

EmHealthReport is a solution that provides the device's battery and eMMC health.

Monitor the battery and eMMC status to foresight their lifetime or find the cause when there is a battery problem such as cannot charge the device or rapid battery discharge.



To use, open **EmKit**  and launch **EmHealthReport** . You can see the simple device health information on main screen. To find detailed information, tap each blue arrow on the right side of the screen.

Figure 79 EmHealthReport



- **Battery Health**
 - Battery Level
 - Battery Age
 - Battery Voltage
 - Battery Temperature
 - System Temperature
 - Smart Charging option
- **eMMC Health**
 - Pre-EOL Information
 - Device life time estimation type A
 - Device life time estimation type B

System Maintenance

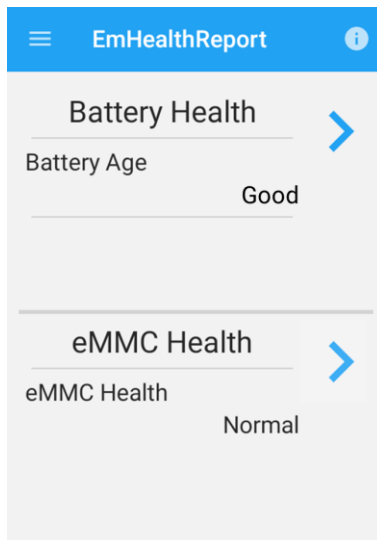
OS Update

Periodic update improves the performance of the device. Point Mobile provides up-to-date OS version via Service Portal and FOTA. Update the device via storage, OTG port, and FOTA server. Depending on the workspace environment, choose more suitable method.



Notice: Please backup your data before starting the update process.

OS update via storage

To update the OS using storage,



1. Download an OS image file into the root folder of microSD card or device internal storage
2. (In case of using SD card) Insert SD card to the device and then turn the device on
3. Go to **Settings**  > **System**  > **Advanced** > **System Update**
4. Check if the OS image file shows up under **AVAILABLE VERSIONS**

Figure 80 OS update via storage



5. Tap **UPDATE** to start the update process



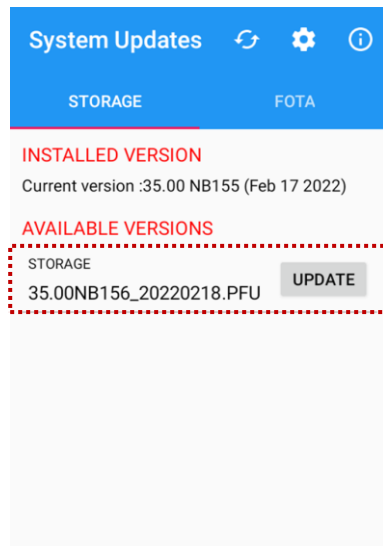

Note: If the OS image file doesn't show up in **AVAILABLE VERSIONS**, check the file is placed in the root folder of storage. System only can recognize the file in the root folder.

System Maintenance

OS update via OTG port

PM351 supports the USB OTG feature.

1. Prepare a formatted USB flash drive for OS update
2. Copy an OS image file to the root folder of the flash drive
3. Connect the flash driver to the PM351
4. Go to **Settings**  > **System**  > **Advanced** > **System Update**
5. Check if the OS image file shows up under **AVAILABLE VERSIONS**
6. Tap **UPDATE** to start the update process

OS update via FOTA

If PM351 can connect to a network, use the FOTA server for the update.



1. Connect the device with a network
2. Go to **Settings**  > **System**  > **Advanced** > **System Update**
3. Tap **FOTA** tab or Swipe left to move to **FOTA** tab
4. If there is an OS version newer than device's one, the server shows the new OS information

Figure 81 OS update via FOTA



System Maintenance

5. Tap **Download**
6. Tap **OK** on the **OS Update** dialog to start to download the OS image file
7. To complete the update, rebooting is required. Tap **OK** on the **Restart required** dialog to restart the device

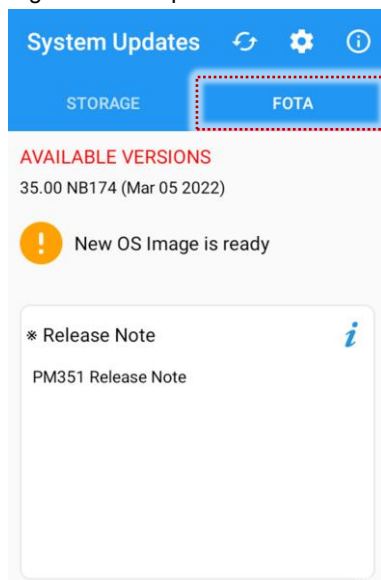
i **Note:** Basically, OS update via FOTA works over Wi-Fi or Ethernet only. To enable the OS update over Mobile Network too, uncheck the setting value in FOTA Settings. Downloading over the Mobile network may result in additional charges.

Figure 82 FOTA Settings

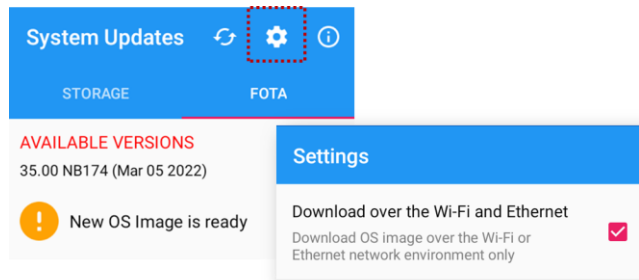

System Maintenance

Factory Data Reset

When PM351 work abnormal or there is a need to reset the device, follow the steps below to perform a factory data reset.



Caution: *Factory data reset will erase all personalized settings and data saved in the device, such as Google account, apps, user data, etc. And factory data reset cannot undo.*

Factory data reset via Settings app

If the device can be turned on and access **Settings**,



1. Navigate to **Settings**  > **System**  > **Advanced** > **Reset options**
2. Tap **Erase all data (factory reset)**
3. After being aware that factory reset will erase all data from the internal storage, tap **Erase all data**

Figure 83 Factory data reset



4. Tap **Erase all data** again to start the factory reset process

System Maintenance

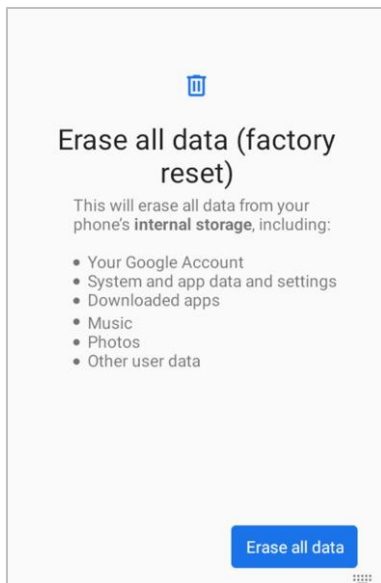
Factory data reset via recovery mode

If device works abnormal so does not turn on, try to perform factory data reset through Android recovery mode.

1. Press and hold **power button + P2 (SOFT_RIGHT) + front scan** buttons simultaneously when PM351 is turned off.

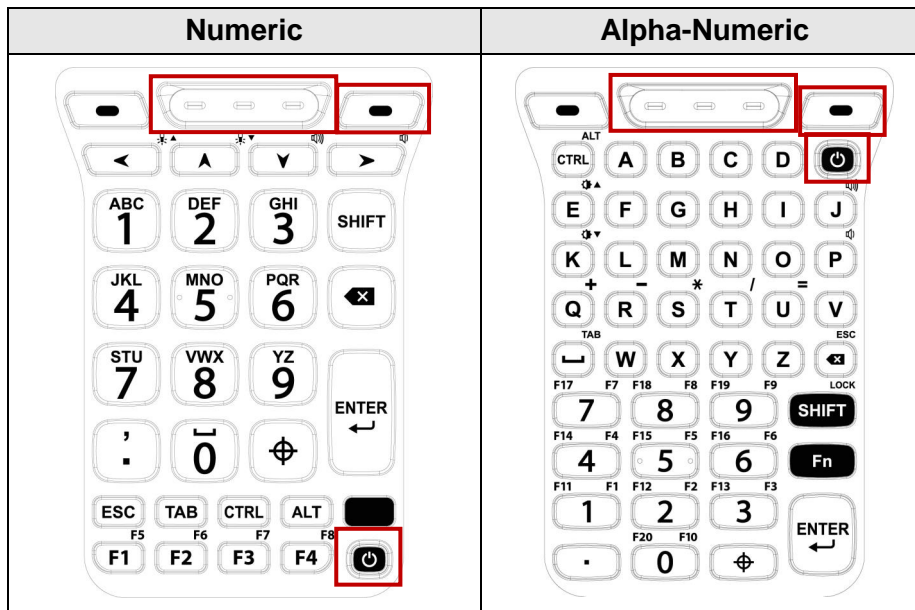

2. After short vibration, release the power button
3. Using the keys below, select **Wipe data/factory reset**
 - **Move down / up** – Press P1 (*SOFT_LEFT*) / P2 (*SOFT_RIGHT*) button
 - **Select the menu** – Press power button or Enter key
4. After wiping the data, select **Reboot system now**

Accessories

PM351 supports below optional accessories.

Category	Accessory Name	Usage
Gun handle	Gun handle	Provide additional scan trigger button (Programmable)
Charging cradle	SSC (Single Slot Cradle)	Charge one PM351 and one PM351 battery Provide USB type C port
	2SC (2 Slot Cradle)	Charge up to two units of PM351
	4SBC (4 Slot Battery Cradle)	Charge up to four pieces of PM351's batteries

Hand Strap

Hand strap is included in PM351 standard package. The hand strap helps users to hold the device easier.

Figure 84 Hand strap

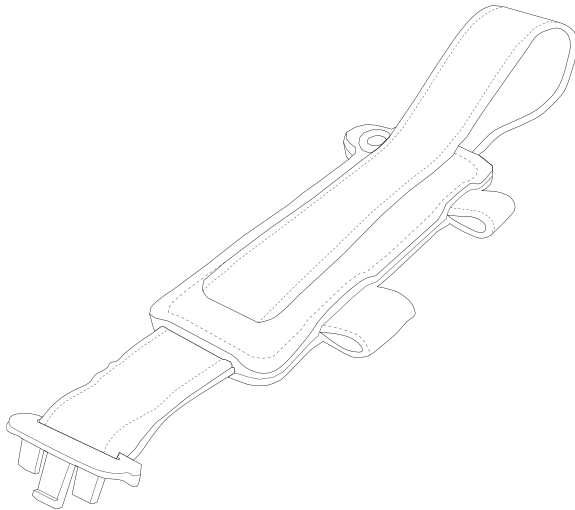

Accessories

Mount hand strap

1. Insert the hand strap bracket to the hand strap hole on the bottom of the device.

Figure 85 Mount hand strap_1

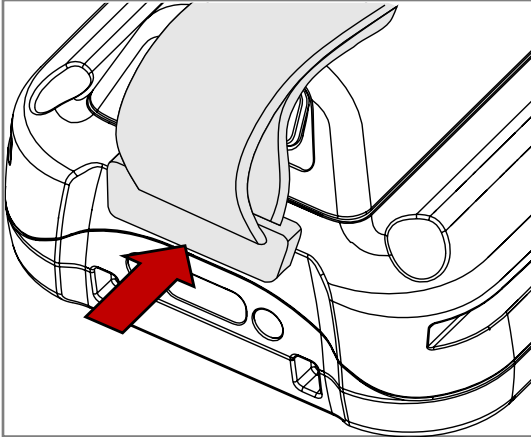

2. Pass the other end of the strap through the hand strap hole on the rear-center side of the device.

Figure 86 Mount hand strap_2

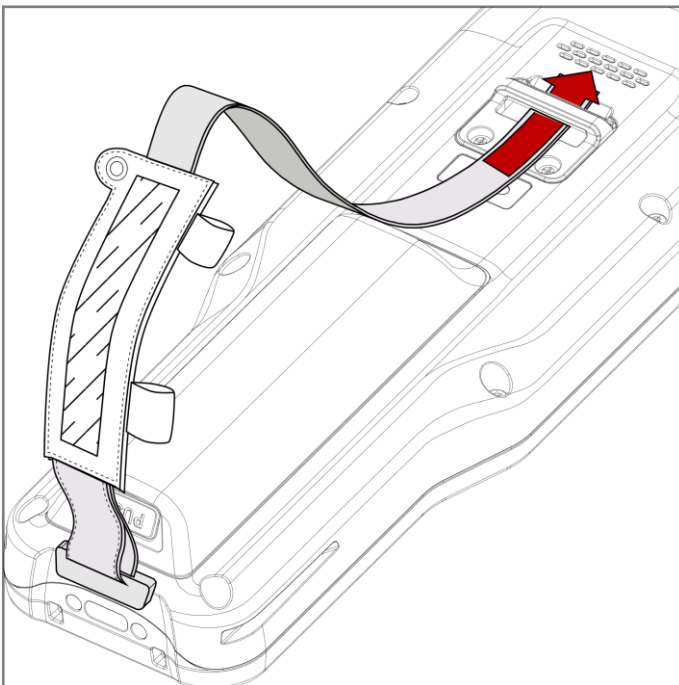

3. Pull the strap and attach the Velcro at the desired length.

Accessories

Gun Handle

Attach a gun handle to PM351 and use additional programmable button. The button is used for triggering scanner usually.

Figure 87 PM351 Gun handle

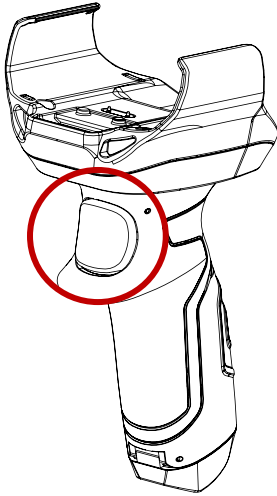

Attach gun handle

1. Align the gun handle around the I/O connector on the rear side of the PM351.
2. Place the left or right side of the PM351 to the gun handle first.
3. Push the other side to engage the gun handle to the device.

Figure 88 Attaching PM351 to gun handle

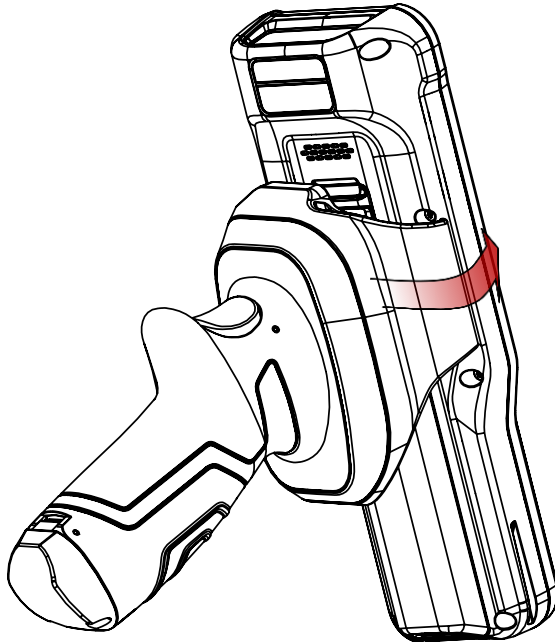

Accessories

Single Slot Cradle (SSC)

SSC has one device slot and one battery slot so that it can charge a PM351 and a battery at the same time. PM351 with gun handle attached can be charged with SSC, too.

In addition to the charging function, the cradle also provides a USB Type C port.

For more detail, see SSC Quick start guide.

Figure 89 Single slot cradle (SSC)

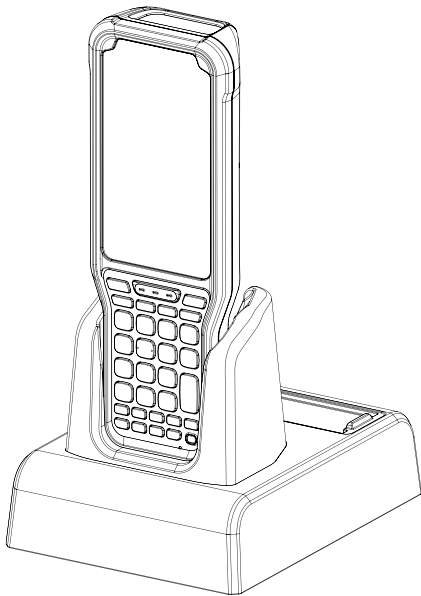

Accessories

2 Slot Cradle (2SC)

2SC has 2 device slots so it can charge up to two units of PM351 simultaneously. PM351 with gun handle attached can be charged with 2SC, too.

Figure 90 2 slot cradle (2SC)

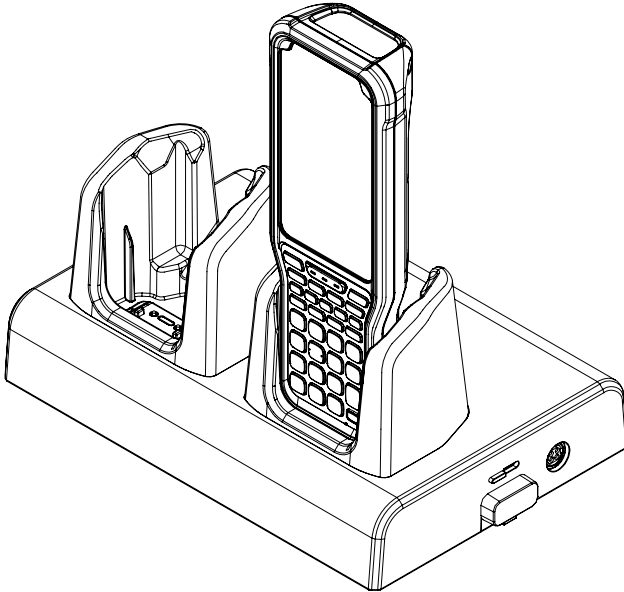

It is possible to connect up to 3 pieces of 2SC to make a share cradle for more charging slots (2SC ~ 6SC). The SKU for making share cradle is sold separately (It contains bracket and screws for connection.)

For more detail, see 2SC Quick start guide.

Figure 91 Share cradle (6SC)

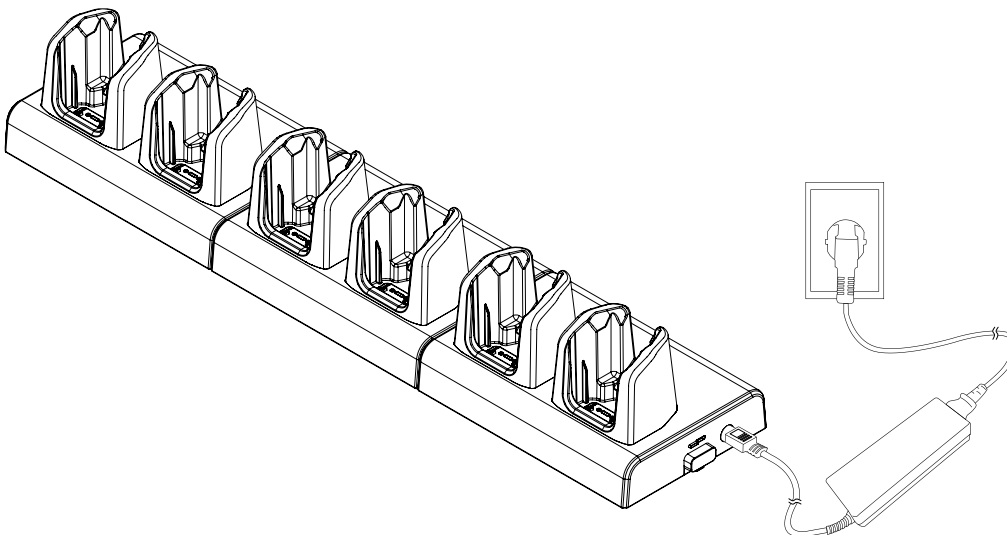

Accessories

4SBC (4 Slot Battery Cradle)

4SBC has 4 battery slots so it can charge up to four pieces of PM351's battery simultaneously.

For more detail, see 4SBC Quick start guide.

Figure 92 4 slot battery cradle (4SBC)

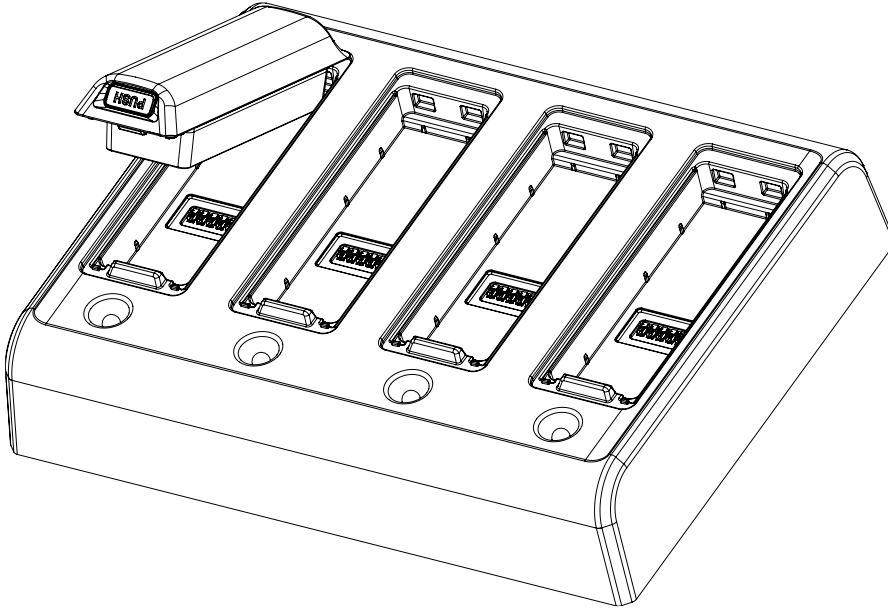

Safety Information

Battery Safety Information

Follow the battery safety guidelines for safe usage, storage, and disposal of Li-ion batteries. Improper battery use may result in a fire, explosion, or other critical hazards.

Battery Safety Guidelines

- Use only Point Mobile approved batteries and charging accessories. Other batteries and chargers may damage the device or result in a fire, leakage, or other hazards.
- Do not expose the battery to excessive heat or cold.
- Do not use or store the battery in or near areas that might get very hot, such as in a parked vehicle, near a heat duct or close to other heat sources.
- Do not allow objects that may cause a short circuit, such as metal objects, corrosive substances, or liquids like water, to contact the battery.
- Do not disassemble, crush, bend, shred, press, or other actions that may damage or deform the battery.
- Do not use or replace the battery on the go or from a high location. Dropping may result in an explosion or fire.
- Do not put any labels, stickers, tags, etc. on the device or battery. Performance of the device or battery, such as sealing, drop, or tumble, could be affected.
- Close supervision is necessary when used near children to avoid the risk of injury.
- If battery leakage is observed, avoid any contact with the skin or eyes and properly dispose of the battery. If contact has been made, wash the affected area with water for 15 minutes and seek medical advice.
- If you notice any type of damage to the battery, such as swelling, dents, and leaks, stop using it immediately and contact Point Mobile.

Battery Charging Guidelines

- Charge the battery in a clean, cool, dry, and ventilated environment.
- Separate the charger from the battery as soon as possible when the battery is fully charged.
- Battery performance can degrade due to the stress of daily charging and discharging. Batteries typically need to be replaced after 300 to 500 charging cycles (full charge-discharge cycles) or when the battery capacity has been reduced to 70 ~ 80% of its original capacity. The actual number of charging cycles varies based on usage patterns, temperature, age, and other factors.

Accessories

Battery Storage / Disposal Guidelines

- Store the batteries in a clean, dry and ventilated environment within ambient temperature ranges of $20\pm 5^{\circ}\text{C}$.
- For safety regulations, batteries are charged to below 20~30% of full capacity during production.
- When not using batteries for a long period, charge the battery for 30 minutes to 1 hour at least once every 6 months to prevent full discharge and keep the performance.
- Batteries should be stored separately when storing for long periods. Disconnect from any device, charger, or cradle.
- Dispose of used batteries promptly according to local disposal regulations.
- Do not dispose of the battery in fire. It may cause explosion.



Notice: The battery is consumable. Point Mobile provides a warranty for the battery for 12 months after purchase.

If you suspect the battery swelling, change the battery immediately and contact Point Mobile.



Point Mobile. Co., Ltd.

Offline

Tel: +82-2-3397-7870~1

ARS: +82-1800-3010

Fax: +82-2-3397-7872

Address: 9F Kabul Great Valley, 32, Digital-ro 9-gil,
Geumcheon-gu, Seoul, Korea 08512

Online

Website: <https://www.pointmobile.com>

E-mail: pm_support@pointmobile.com