



For Android™ 11

# Enterprise Mobility

## **PM67**

# User Manual

# Instruction

---

This manual provides information about basic features and using the PM67. Please read this manual carefully before using your handy payment device and peripherals to ensure safe and proper use.

 **Note:** Screenshots in this manual may differ from actual screens.

## Revision History

Revision	Date	Description
V01	25 Jun 2021	Initial release
V02	15 Jul 2021	Updated Battery safety information chapter
V03	22 Jul 2021	Updated Stylus pen figure in Product Standard Accessories
V04	27 Mar 2023	Updated PM67 SKU list Added Use Keyboard Backlight chapter Updated Battery safety information chapter

# Instruction

---

## PM67 SKUs

The contents of this manual can cover the following SKUs.

SKU	Part Number	Network	RAM /Flash	Scanner	NFC	Common
SKU1	PM67GPV23BJX0C	WiFi/BT	3G/32G	N3601 SR		Bluetooth 5.1, Numeric Keypad Rear Camera Android GMS 11
SKU2	PM67G6V23BJX0C	LTE, GPS, WiFi/BT			O	
SKU3	PM67G6Q23DJE0C	LTE, GPS, WiFi/BT	4G/64G	N6603	O	
SKU4	PM67GPQ23DJE0X	WiFi/BT				

# Table of Contents

---

<b>INSTRUCTION .....</b>	<b>1</b>
Revision History .....	1
PM67 SKUs .....	2
<b>GETTING STARTED .....</b>	<b>7</b>
Device Parts .....	7
Product Standard Accessories.....	9
Install SIM & SD card.....	10
About SIM card.....	10
About SD card .....	11
Install & Remove Battery .....	13
Install the battery .....	13
Remove the battery .....	15
Charge the device.....	16
Battery specification .....	16
Charge with power adapter.....	16
Charging Cradle .....	17
LED indicator .....	20
Turn on & off PM67.....	21
Use a touch screen.....	22
<b>LEARNING THE BASICS.....</b>	<b>24</b>
Setup Wizard .....	24
Home Screen.....	25
Status bar .....	26
Notification panel .....	27
Quick setting panel .....	28
Apps & Widget.....	29
Recently Used Apps .....	33

# Table of Contents

---

Call.....	34
Making a call.....	34
Answering a call .....	36
Contacts.....	37
Add a contact.....	37
Contact detail.....	38
Message .....	39
MTP Connection with PC.....	40
Manage the Files .....	41
Lock the Screen.....	43
Settings.....	44
Adjust display brightness .....	44
Adjust sound.....	44
Use Keyboard Backlight .....	45
Adjust font size .....	46
<b>USING THE KEYPAD.....</b>	<b>47</b>
Keypad.....	47
Use the Buttons .....	49
Screen capture .....	49
Program buttons .....	49
<b>CAMERA .....</b>	<b>51</b>
<b>SCANNER .....</b>	<b>52</b>
Turn on / off the Scanner .....	52
ScanSettings.....	53
Basic.....	53
Options .....	54
Notification.....	55
Wedge .....	56

# Table of Contents

---

Extended wedge .....	57
Symbologies .....	61
About .....	61
Scan a Barcode .....	62
N3601 Scanner SKU (SKU1, SKU2) .....	62
N6603 Scanner SKU (SKU3).....	63
ScanDemo .....	63
<b>WIRELESS .....</b>	<b>64</b>
Mobile Network (LTE SKU Only).....	64
Wi-Fi .....	65
Bluetooth.....	66
Turn on / off .....	66
Pair and Connect.....	66
Unpair and Disconnect .....	67
Change the Bluetooth device details .....	68
NFC (NFC SKU Only) .....	69
<b>SYSTEM MAINTENANCE .....</b>	<b>70</b>
System Information .....	70
On Settings.....	70
On EmKit .....	70
Check Device Health .....	71
OS Update .....	72
OS update via storage .....	72
OS update via OTG port.....	73
OS update via FOTA .....	73
Factory Data Reset .....	75
Factory data reset via Settings app .....	75
Factory data reset via recovery mode .....	76

# Table of Contents

---

<b>ACCESSORIES .....</b>	<b>77</b>
Hand Strap.....	77
Mount hand strap.....	78
Remove hand strap .....	79
Gun Handle.....	80
Attach gun handle.....	81
Mount hand strap.....	82
Single Slot Cradle (SSC / SEC) .....	83
4SC (4 Slot Cradle).....	83
4SBC (4 Slot Battery Cradle) .....	83
<b>SAFETY INFORMATION.....</b>	<b>84</b>
Battery Safety Information .....	84

# Getting Started

## Device Parts

Figure 1 PM67 Front View

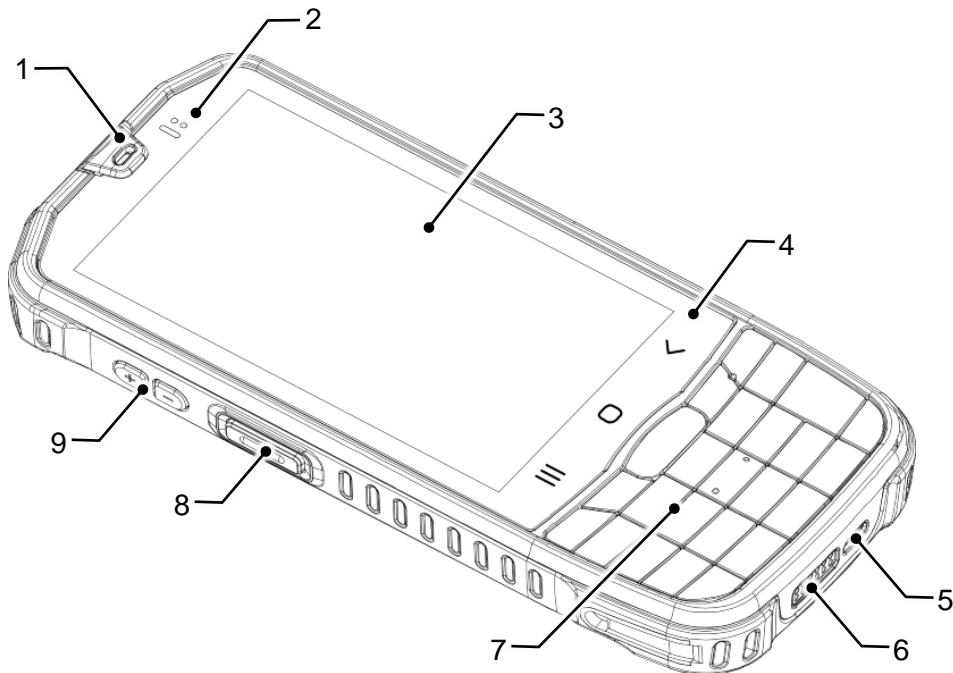

No	Name	Description
1	Receiver	Use with making a phone call
2	LED indicator & Sensor	Indicate the power status and notification (Find more details on <a href="#">LED indicator</a> )
3	Touch screen	Display all operating screen
4	Software buttons	III (Recent app button) : List up the recently used apps ○ (Home button) : Go to home screen ◀ (Back button) : Go back to previous screen
5	USB connector	USB 2.0 Type C / OTG
6	I/O connector	Pogo 12 pin type
7	Keypad	Numeric keypad (For more details, refer to <a href="#">Using the Keypad</a> )
8	Scan button (Left)	Scan a barcode by pressing
9	Volume button	Control the volume



# Getting Started

Figure 2 PM67 back view

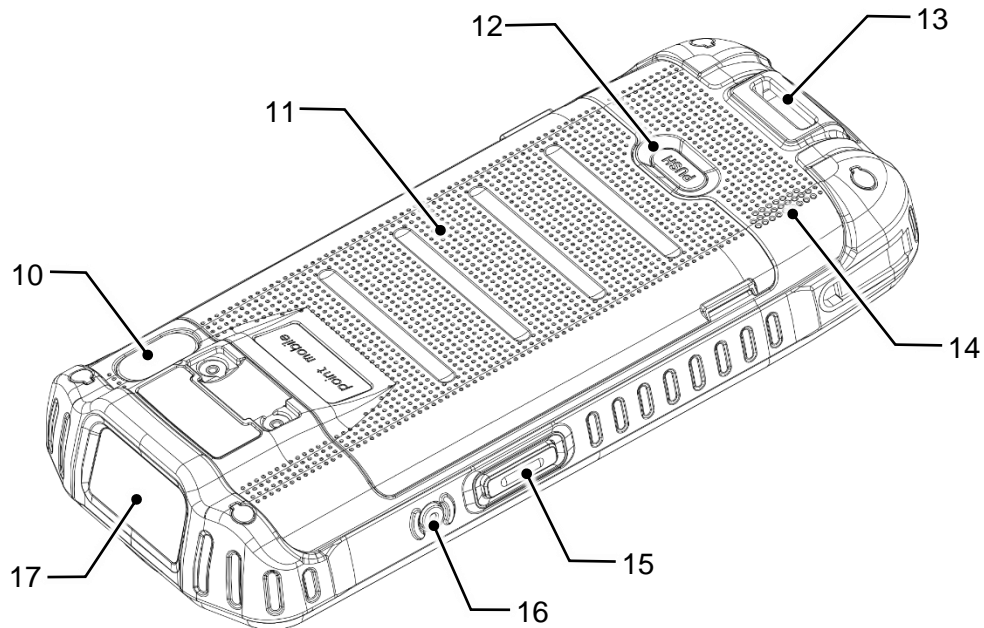

No	Name	Description
10	Rear camera & Flashlight	Take a picture & Use flashlight in camera or torch mode
11	Battery cover	Protect the battery from detaching and damage
12	Battery cover release button	Press to release the battery cover and replace the battery
13	Hand strap hole	Mount hand strap
14	Speaker	Ring system sound
15	Scan button (Right)	Scan a barcode by pressing
16	Power button	Turn on/off the device
17	Scanner	Scan a barcode

# Getting Started

## Product Standard Accessories

The following items are in the product box.

Accessory	Name
	Battery pack
	AC/DC Power supply
	Country plug
	USB type C cable
	LCD protection film
	Hand strap (Mounted on the device)
	Stylus pen



**Note:** The images may differ from the actual accessory.

# Getting Started

## Install SIM & SD card

PM67 supports

- micro SIM card - LTE SKU (SKU2, SKU3) only
- microSD card

Refer to the table to find out the difference.

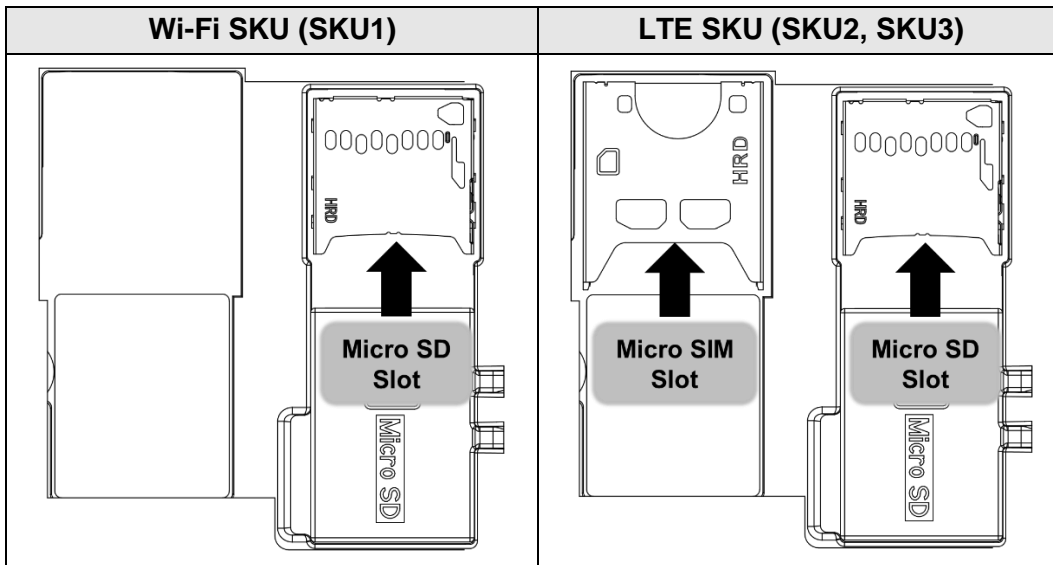

## About SIM card

To install the SIM card,

1. Open the battery cover while pressing the battery cover release button.  
Using the small hole on both sides of the cover, pull it up.

Figure 3 Open battery cover

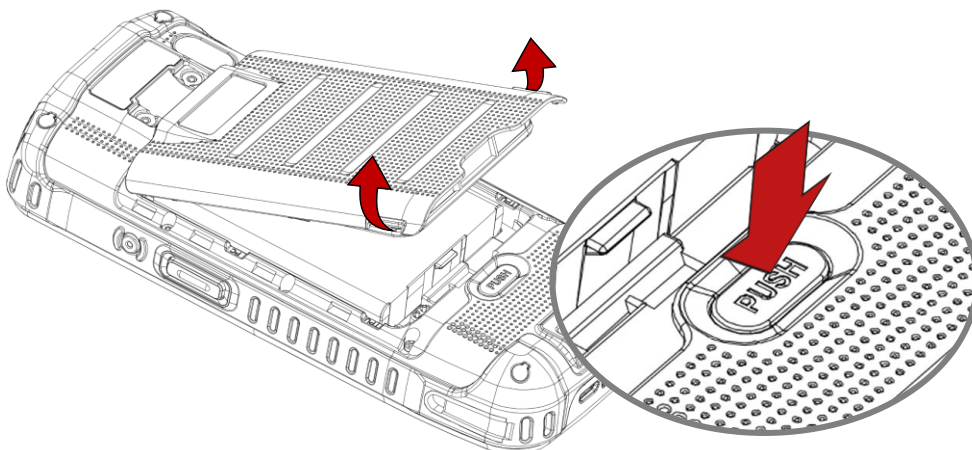

# Getting Started

---

2. Slide the card into the slot with the contacts facing down.

Figure 4 Inserting SIM card

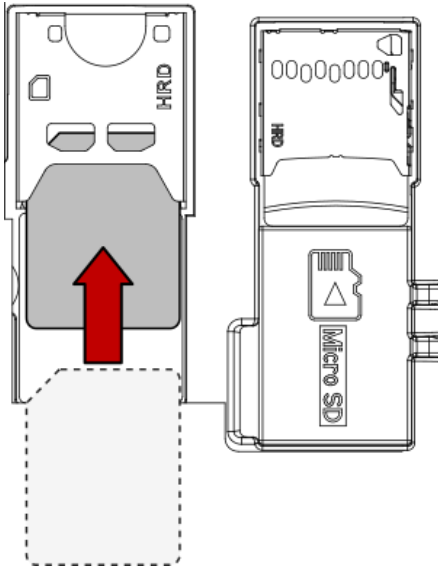

3. To remove the card, gently slide the card out from the slot.

## About SD card

To install the micro SD card,

1. Open the battery cover.
2. Lift the rubber on the bottom side of the slot.

Figure 5 Opening rubber of the SD card slot

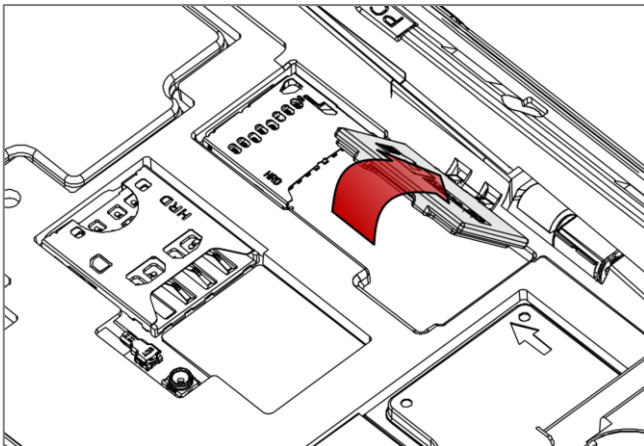

# Getting Started

---

3. Slide the card into the slot with the contacts facing down.

Figure 6 Inserting SD card

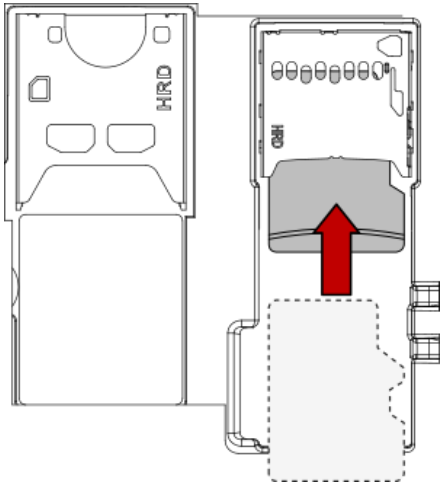

4. To remove the card, gently slide the card out from the slot.

# Getting Started

## Install & Remove Battery

### Install the battery

1. Open the battery cover while pressing the battery cover release button.  
Using the small hole on both sides of the cover, pull it up.

Figure 7 Open battery cover

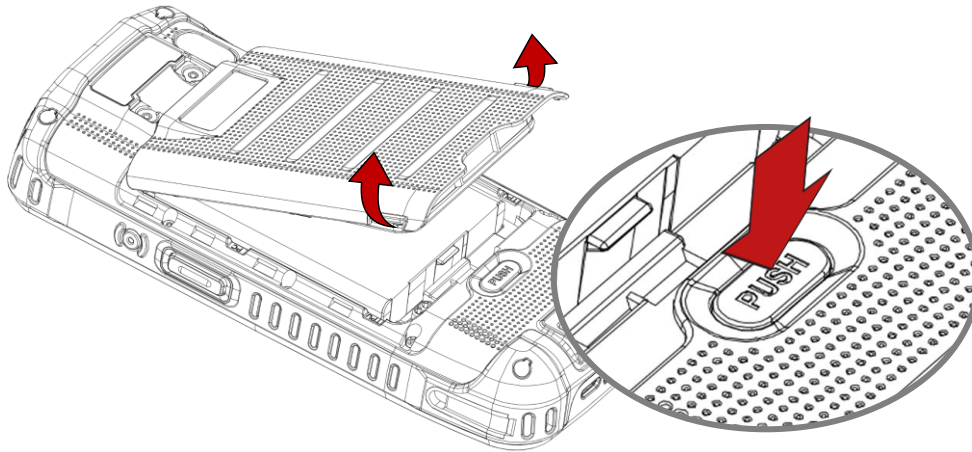

2. Align the connector (gold contact) of the battery with the battery connector of device.
3. Insert top of the battery directly into the top of the slot.

Figure 8 Insert battery\_1

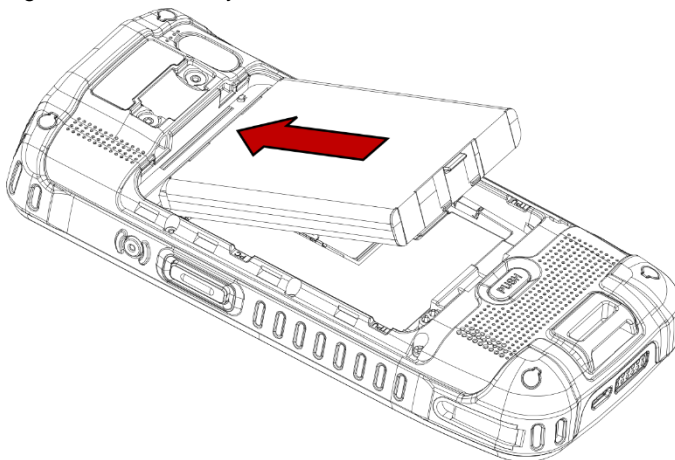

**Caution:** Don't slide the battery over the battery connector of the device while inserting the battery. It may damage the connector pin.

# Getting Started

---

4. Push down the bottom side of the battery.

Figure 9 Insert battery\_2

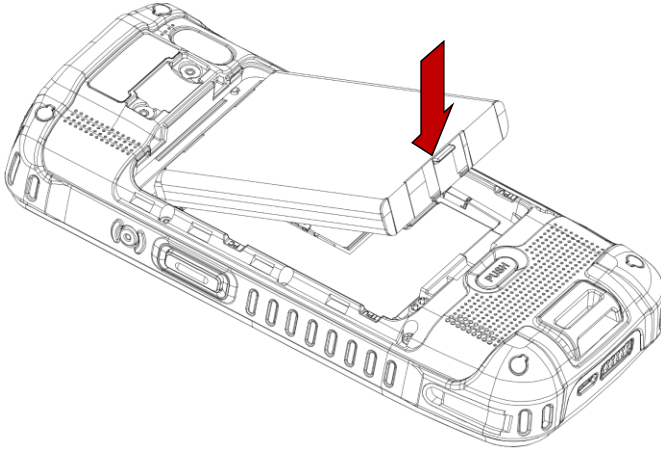

5. Engage the battery cover from the top, and then press the edge of the cover to close it firmly.

Figure 10 Close battery cover

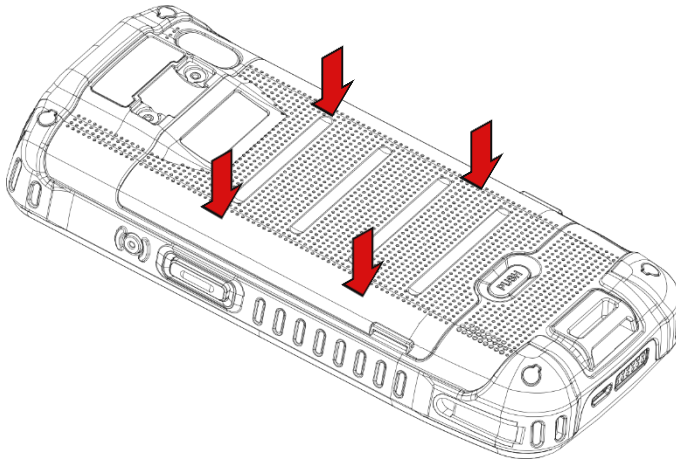

# Getting Started

---

## Remove the battery

1. Open the battery cover.
2. Push the battery towards the up side of the device, and pull the battery up from the bottom.

Figure 11 Remove battery

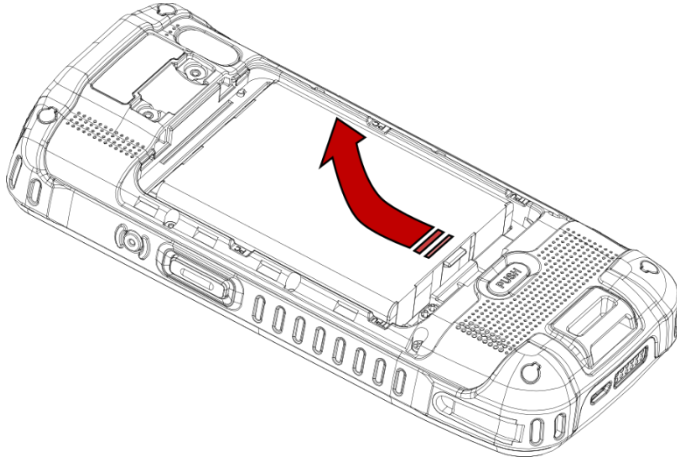

## Battery Hot Swap

PM67 supports the Battery hot swap mode which allows you to replace the battery without turning off the device. When the battery is removed from the device, the display turns off and the device enters Hot swap mode (For verification, a red LED will be turned on). In Hot swap mode, data is retained about 5 minutes.

Once you replace the battery to a new one and close the battery cover firmly, the device will come back to normal operation mode without booting process.



# Getting Started

---

## Charge the device

Before using PM67, charge the device enough to use. PM67 can be charged with power adapter or charging cradle.

### Battery specification

- Capacity: 4,200mAh / 3.85V
- Rechargeable & Removable battery

### Charge with power adapter

**⚠ Caution:** Always use an original charger and cable from Point Mobile. Other chargers and cables may damage PM67. Also, make sure the charger and cables are not wet. Follow the [battery safety Information](#) for safety of using the battery.

1. Assemble the country plug, AC/DC power supply and USB type C cable.
2. Connect the cable to the USB connector of PM67.
3. Provide power by plugging the power supply to the wall socket.

Figure 12 Charging PM67

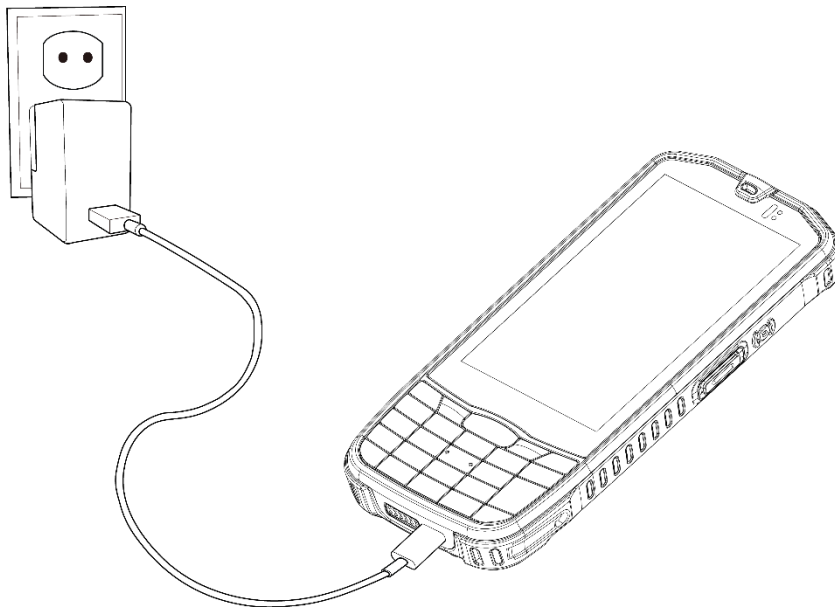

# Getting Started

---

## Charging Cradle

There are three types of charging cradle for PM67. Single slot cradle (SSC / SEC), 4 slot cradle (4SC), 4 slot battery cradle (4SBC). The cradles are sold separately.

### SSC / SEC

SSC (Single Slot Cradle) and SEC (Single slot Ethernet Cradle) can charge one PM67 and one battery of PM67. SEC has an ethernet port that is not included in SSC.

To charge PM67 using SSC/SEC,

1. Assemble the power adapter and AC plug, and connect it to the cradle to provide power.
2. Install PM67 and confirm the connection with LED indicator of PM67.

(Refer to [LED indicator.](#))

Figure 13 Charging PM67 via SSC / SEC

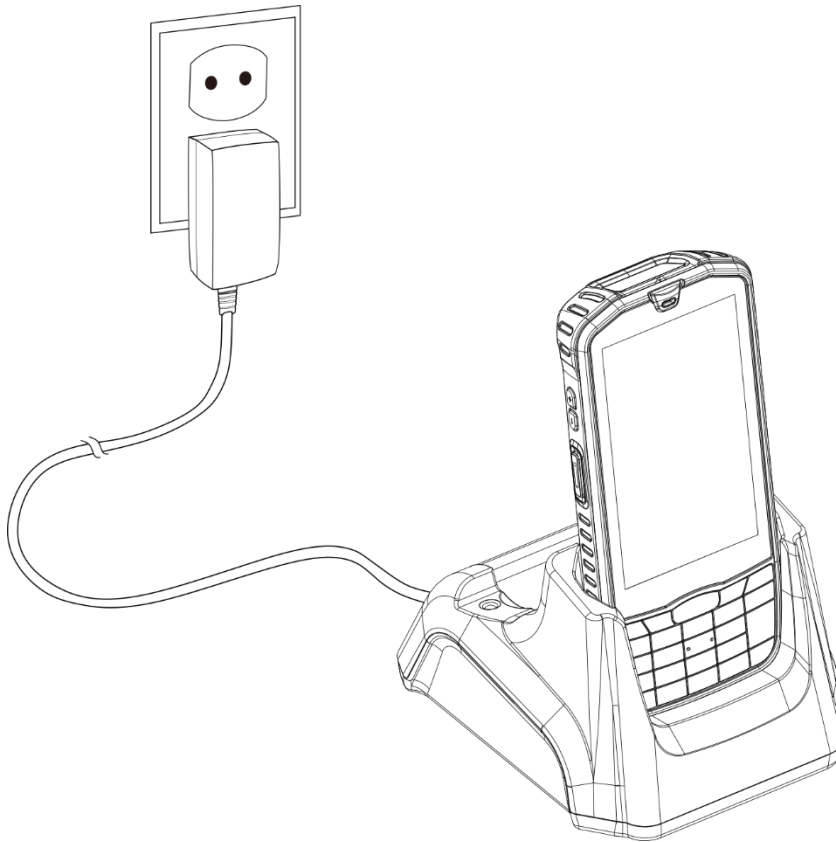

# Getting Started

---

## 4SC

4SC (4 Slot Cradle) can charge up to four unit of PM67 at the same time.

To charge PM67 using 4SC,

1. Assemble the power adapter and cable, and connect it to the cradle to provide power.
2. Install PM67 and confirm the connection with LED indicator of PM67.

(Refer to [LED indicator.](#))

Figure 14 Charging PM67 via 4SC

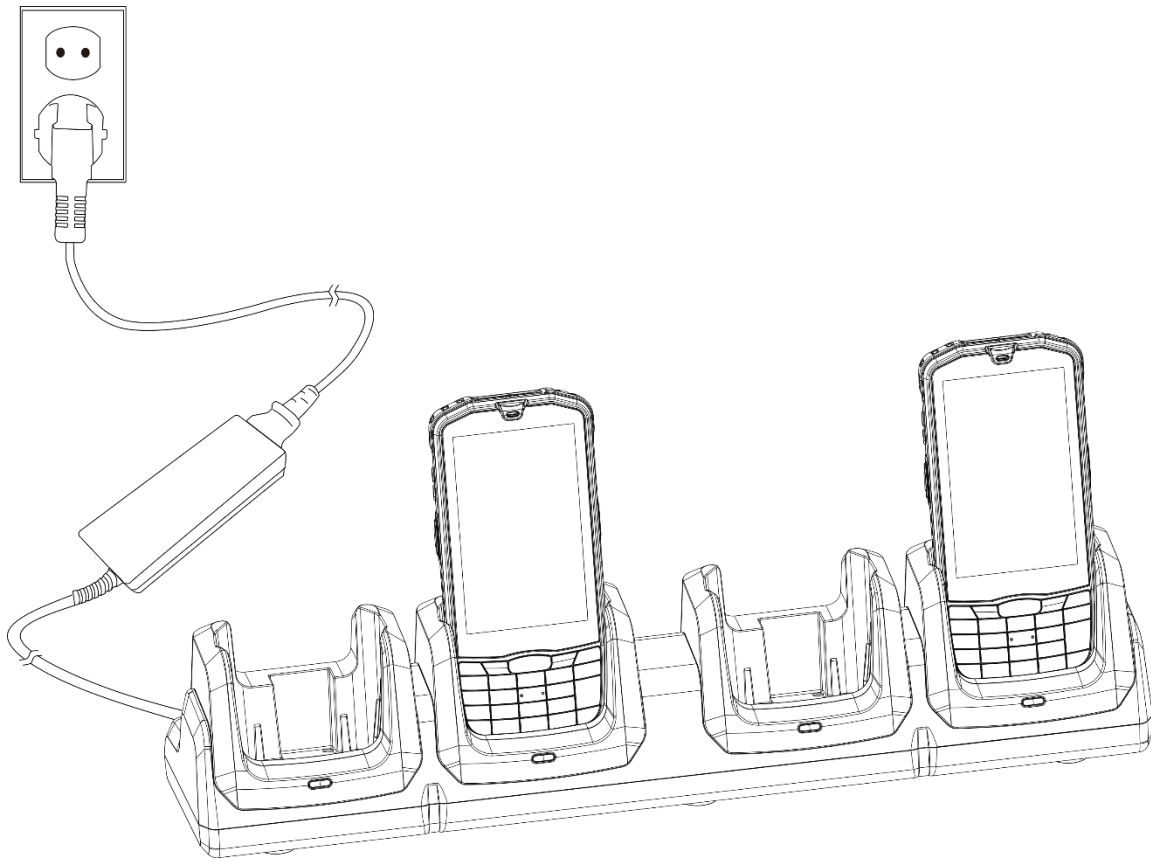

# Getting Started

---

## 4SBC

4SBC (4 Slot Battery Cradle) can charge up to four pieces of PM67 battery at the same time.

To charge the battery using 4SBC,

1. Assemble the power adapter and cable, and connect it to the cradle to provide power.
2. Insert the battery and confirm the connection with LED indicator of the cradle.  
(Red – Charging / Green – Fully charged)

Figure 15 Charging PM67 battery via 4SBC

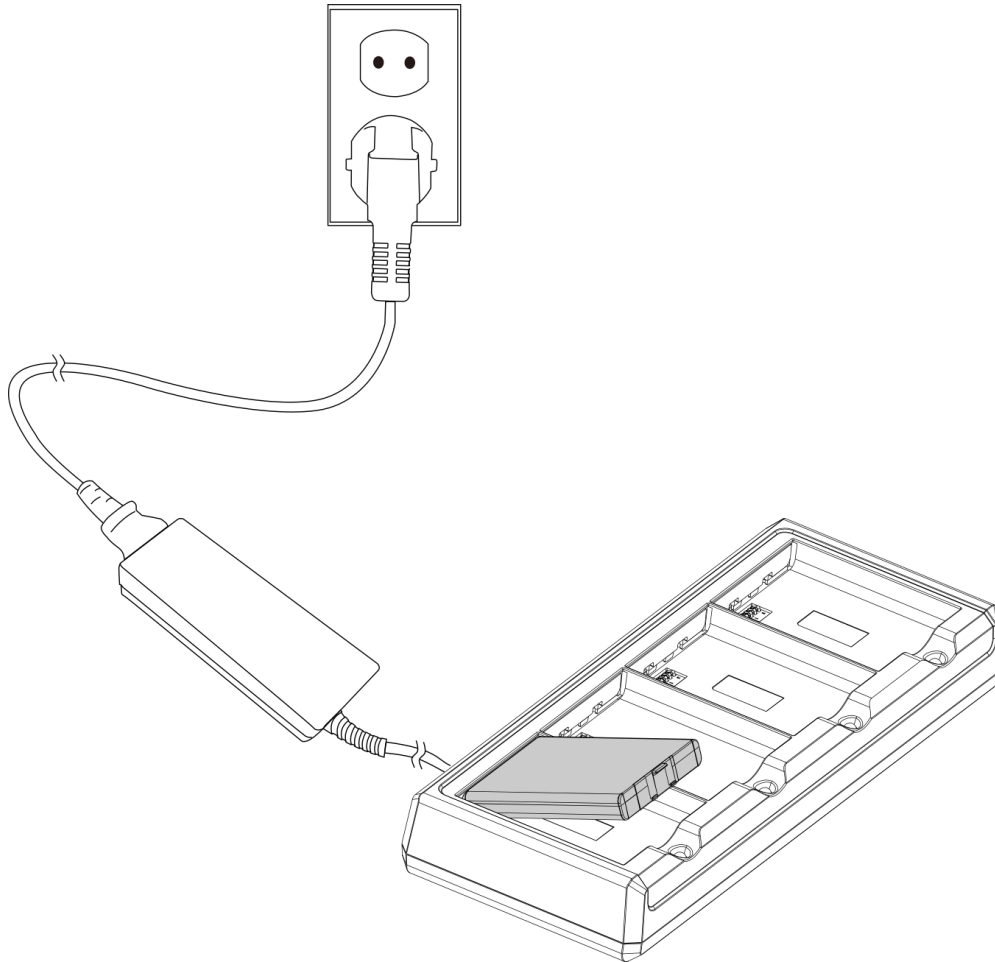





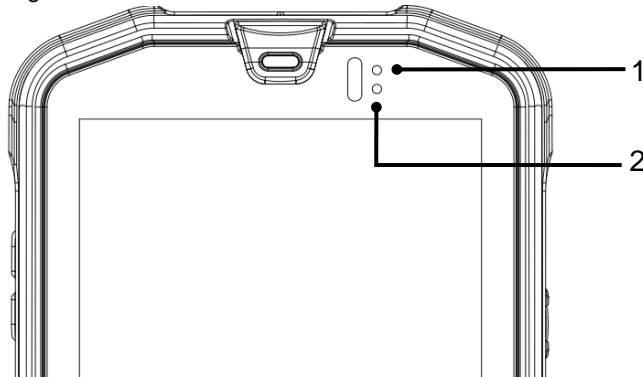

# Getting Started

## LED indicator

Figure 16 LED Indicator



No	Indicator	Status	Indication
1	Power LED	 Solid red	Charging the device (With charger) / Battery is low (Without charger)
		 Blinking red	Charging temperature is too low or too high (With charger) / Battery is critical low (Without charger)
		 Solid green	Device is fully charged
2	Notification LED	 Blinking blue	Notification existing
		 Red flash	Barcode reading failed
		 Blue flash	Barcode reading success

# Getting Started

---

## Turn on & off PM67

To turn on the device,

- Press and hold the **power** button on the right side of the PM67 until **SMART BEYOND RUGGED** logo displays on the screen.

Figure 17 Power button

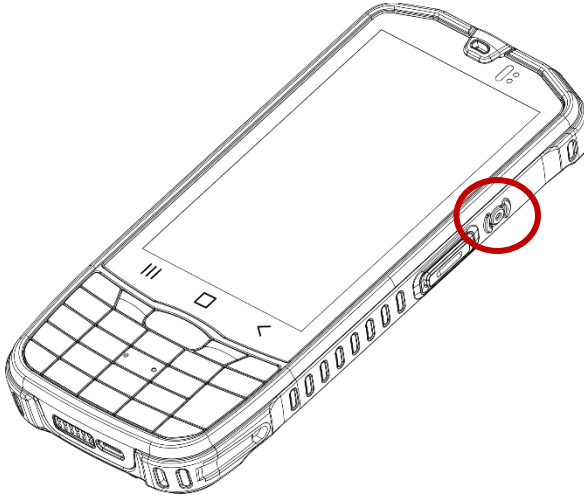

To turn off the device,

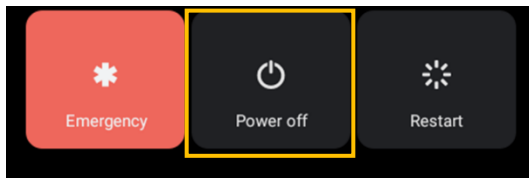

- Press and hold the **power** button until the power menu is shown when the screen is on. Then, tap **Power off**.

Figure 18 Power menu

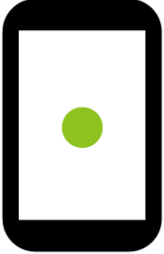

# Getting Started

## Use a touch screen

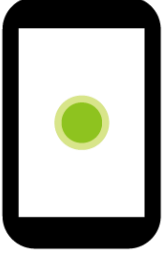
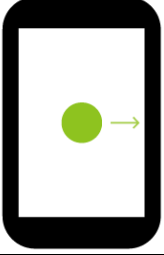
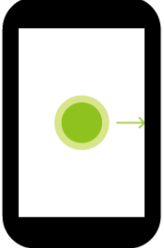
Gesture	Description
	<p><b>Tap</b> One-finger press</p>
	<p><b>Double tap</b> One-finger press, lift, one-finger press, lift for <b>zoom in</b> action</p>
	<p><b>Long-press</b> One-finger press, wait, lift for <b>select</b> action</p>
	<p><b>Drag, Swipe, or Fling</b> One-finger press, move, lift for <b>scroll or tilt</b> action</p>
	<p><b>Long-press drag</b> One-finger press, wait, move, lift for <b>pick up and move</b>, or <b>select multiple items</b> action</p>

# Getting Started

---

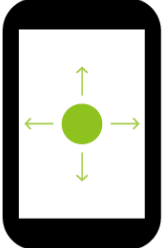
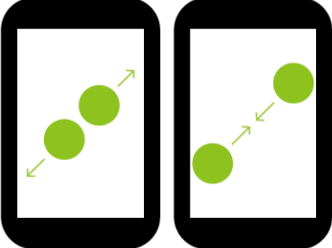
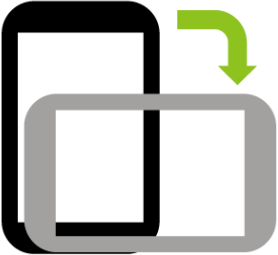
Action	Description
	<p><b>Scroll</b> Vertical or horizontal swipe in a single direction</p>
	<p><b>Pinch Open &amp; Close</b> Two-finger press, move outwards and inwards, lift for <b>zoom in / out</b> action</p>
	<p><b>Rotate</b> When PM67 is turning sideways, <b>screen orientation is changing</b></p>



# Learning the Basics

---

## Setup Wizard

When PM67 starts very first time or boot after factory reset, Setup wizard is launched. Following the steps on the screen, set system language, Google account, Wi-Fi connection and copy the data, etc. Some settings can be skipped, but there may be restrictions on the use of system.

Figure 19 Setup wizard - main

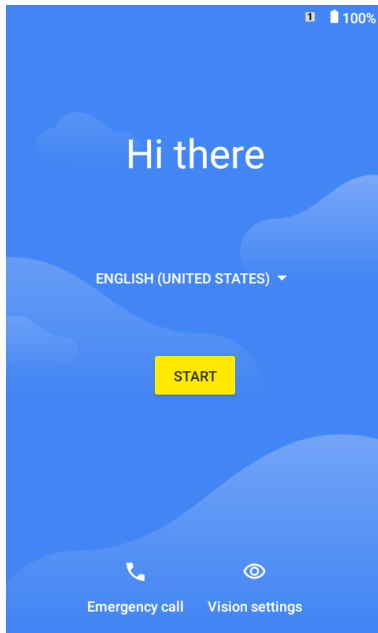
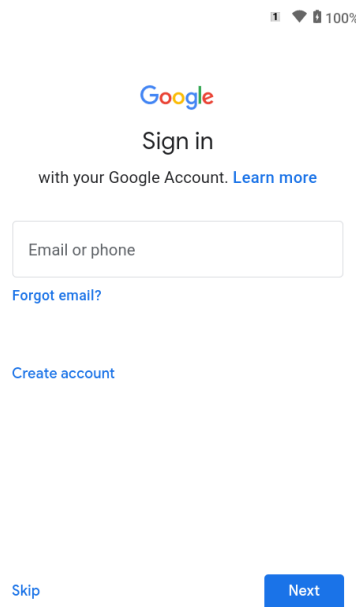

Figure 20 Setup wizard - Google account



# Learning the Basics

## Home Screen

Home screen is a screen displayed after Setup wizard or pressing the Home button.

Figure 21 Home screen

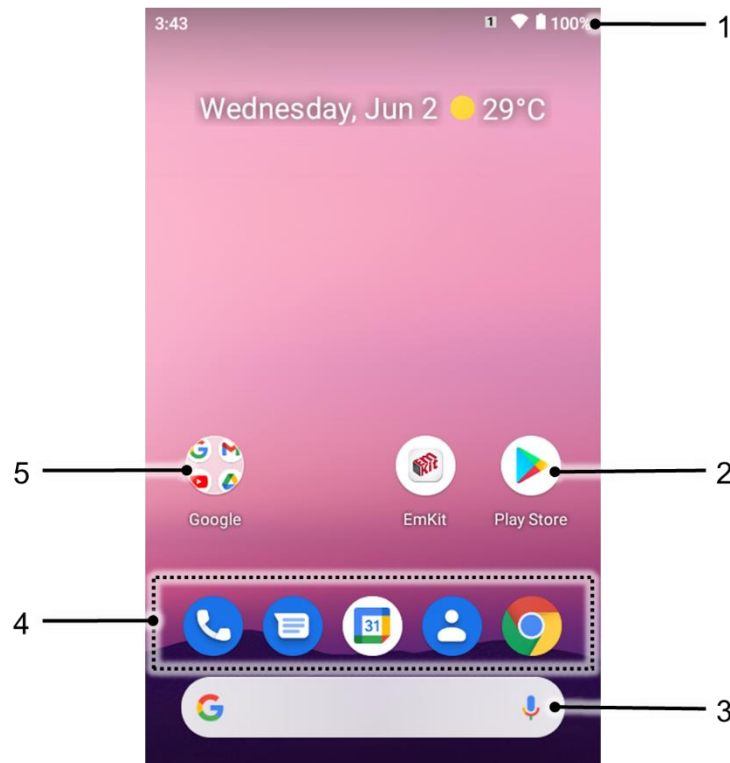



































No	Item	Description
1	Status bar	Indicates device status and notification.
2	App	Tap to run the application Long-press to see the application's options
3	Google search	Search an item with Google
4	Favorites tray	Place the frequently used apps
5	App folder	Apps are organized in the folder. Tap to open the App folder

# Learning the Basics

## Status bar











Time, status icons, and notification icons are on the Status bar.

### Status icons

Icon	Description	Icon	Description
	LTE connected		Strong signal
	3G connected		Good signal
	EDGE connected		Weak signal
	LTE+ (LTE CA) connected		Connection issue
	VoLTE enabled		Data disabled
	Airplane mode		No data connection
	Data communication		Hotspot enabled
	Connected to a Wi-Fi network		Wi-Fi data communication
	Connected to a Bluetooth device		
	Battery is full		Battery is partially drained
	Battery is low		Battery is critical low
	Battery is charging		Cannot recognize battery
	Location service turned on		Vibrate mode
	Speakerphone turned on		Phone mic is mute
	Scanner turned on		Scanner turned on, but trigger turned off
	Alarm is set		
	Numeric input mode		Uppercase alphabet input mode
	Lowercase alphabet input mode		Functions input mode

# Learning the Basics

## Notification icons

Icon	Description	Icon	Description
	Missed call		New SMS or MMS message
	New Email		Connected to VPN network
	Upcoming event		Other input method available
	File uploaded		File downloaded
	File copied		OTG device connected
	There are more notifications		

## Notification panel

Notification panel displays a list of all notifications. Tap a notification to respond. To open the Notification panel, drag the Status bar down. To close the panel, swipe it up.

Figure 22 Notification panel

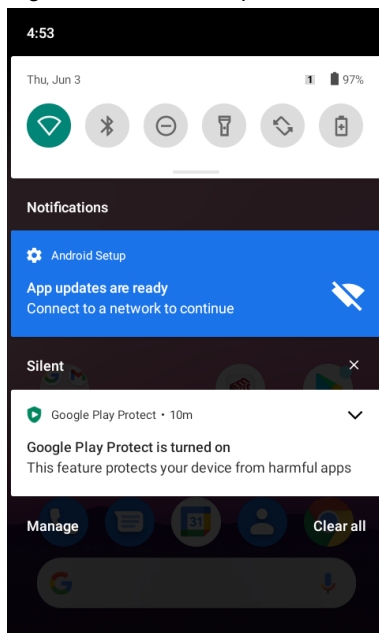

# Learning the Basics

---

## Quick setting panel

Quick setting panel contains some frequently used settings such as Wi-Fi, Bluetooth, etc. To use the Quick setting panel,

1. Open the Notification panel.
2. Drag down the Notification panel.

Figure 23 Quick setting panel

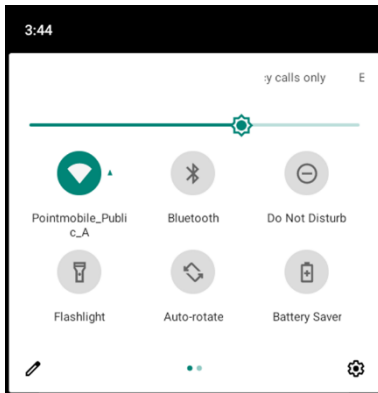

3. Tap a setting icon to enable / disable the setting or long-press an icon to see more detail.

To edit the configuration of Quick settings panel,

1. Tap  on the bottom of the panel.
2. By long-press and dragging the icon, customize the configuration of the panel.

# Learning the Basics

---

## Apps & Widget

### App folder

To create the app folder, long-press an app icon and drag it to another app icon.

Figure 24 Create app folder



To change the folder name, tap the **Unnamed Folder** and input a new name.

Figure 25 Change app folder name

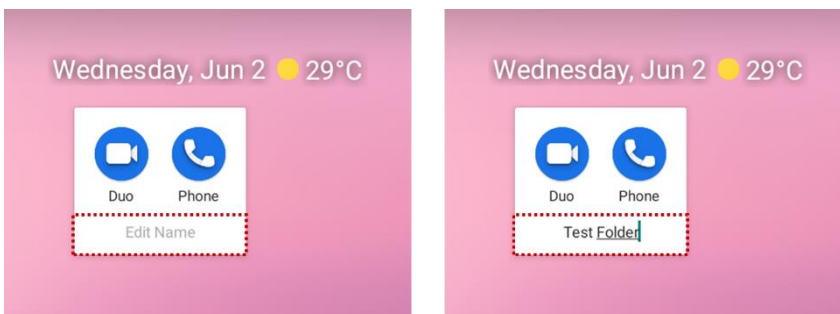

# Learning the Basics

---

## App drawer

All installed apps are listed alphabetically in App drawer.

- To open the App drawer, swipe up the Home screen.
- To close the App drawer, swipe down the Home screen.

Figure 26 App drawer

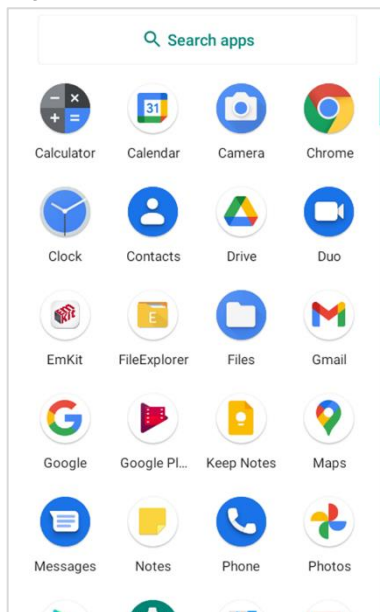

## Favorites tray

To organize an app in the Favorites tray,

1. Long-press an app icon from the App drawer. Then, drag it slightly until the Home screen is shown.
2. Place the app icon in the Favorites tray.

Figure 27 Add an app to Favorites tray



# Learning the Basics

---

## Organize app in Home screen

To organize an app in the Home screen,

1. Long-press an app icon from the App drawer. Then, drag it slightly until the Home screen is shown.
2. Place the app icon where you want.

(To cancel to place the app, drag it to **Cancel** area and release.)

Figure 28 Place app in Home screen

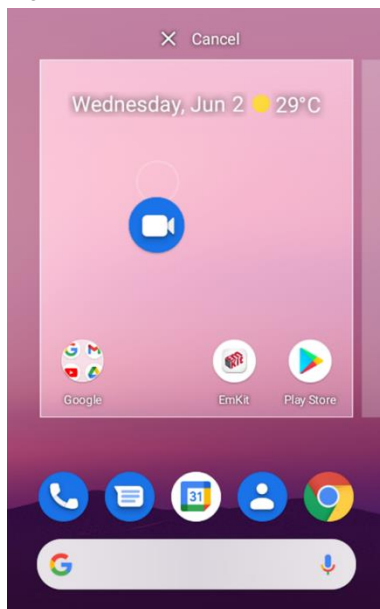

## Widget

To add a widget in the Home screen,

1. Long-press the empty space of the Home screen.
2. In three menus, select **Widgets**.

Figure 29 Widget menus

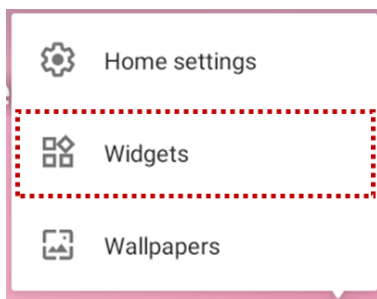



# Learning the Basics

3. Among the list, tap and hold a widget you want to add.

Figure 30 Widget list

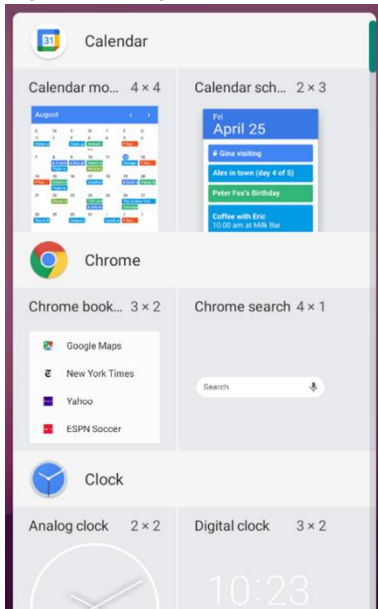

4. Place the widget to the Home screen by dragging.

**i** **Note:** To remove an app or a widget from the Home screen, long-press and drag it to **Remove** area.

Figure 31 Remove from Home screen



# Learning the Basics

---

## Recently Used Apps

Touch Recent apps button to see recently used apps list.

Figure 32 Recent apps button



From the list, tap an app to open or completely close the app by swiping it up.

Figure 33 Recently used apps

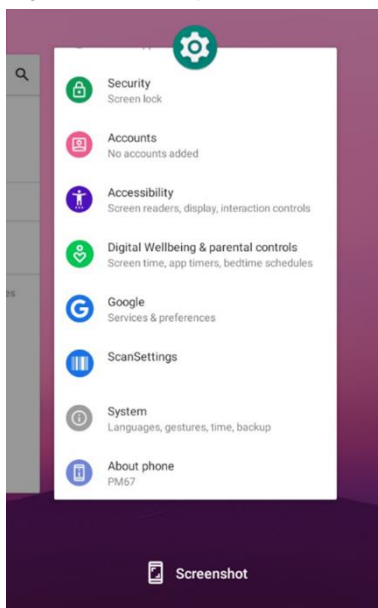

# Learning the Basics

---

## Call

To make or receive a phone call, SIM card is required. Insert SIM card to PM67 first regarding [Install SIM & SD card](#).

### Making a call





1. Tap **Phone**  from Home screen or App drawer.
2. Tap  to open a dialer.
3. Input a phone number.

Figure 34 Dialer





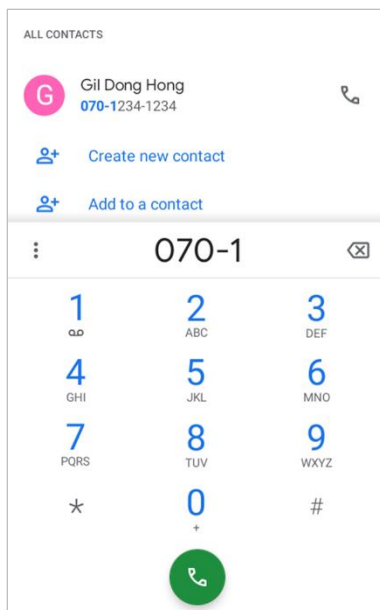

4. Tap  or  next to a searched number to make a call.

# Learning the Basics

5. Control the Tap  to hang up the phone.

Figure 35 Calling screen



Icon	Function Name	Description
	Mute	Mute microphone
	Keypad	Open the keypad
	Speaker	Speakerphone mode
	Add call	Add another call (Enable when receiver answer the phone)

# Learning the Basics

---

## Answering a call

Check the caller's name and number and tap **ANSWER** button to answer the phone call. Or tap **DECLINE** button to decline the phone call.

Figure 36 Receiving call

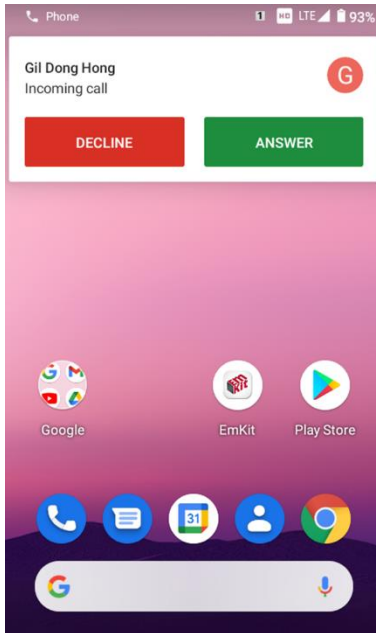

# Learning the Basics

## Contacts

### Add a contact

#### Add a contact via dialer

1. Navigate to dialer through Phone, and enter the number.
2. Tap **Create new contact** or **Add to a contact** to save the number.
3. Input additional information.
4. Tap **Save**.

#### Add a contact via contacts app



Navigate to **Contacts**  from App drawer and tap  to add a new contact.

Figure 37 Add new contact via Contacts



Enter the contact details and tap **Save**.

# Learning the Basics

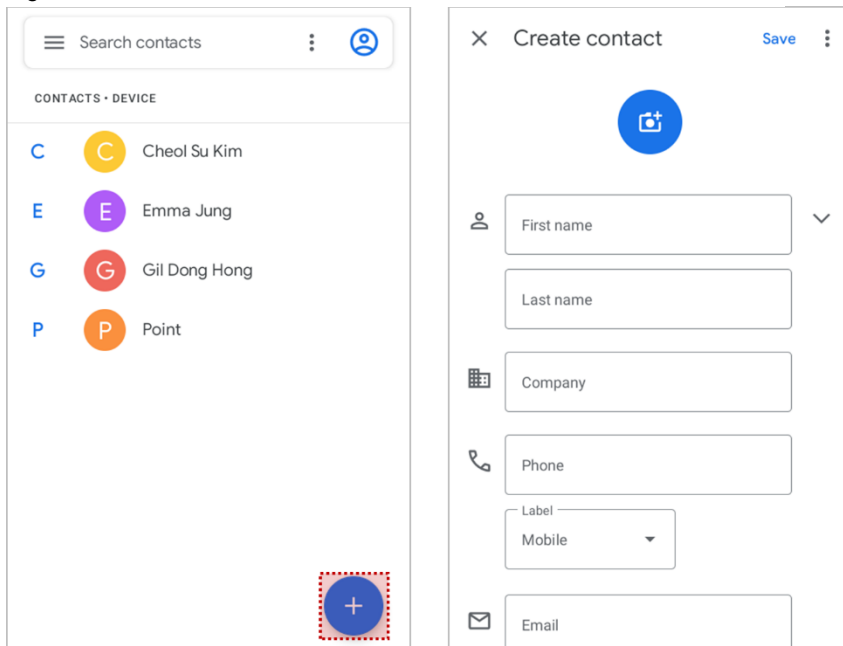
## Contact detail

Select a contact from the list to find more detail information.

Figure 38 Contact detail

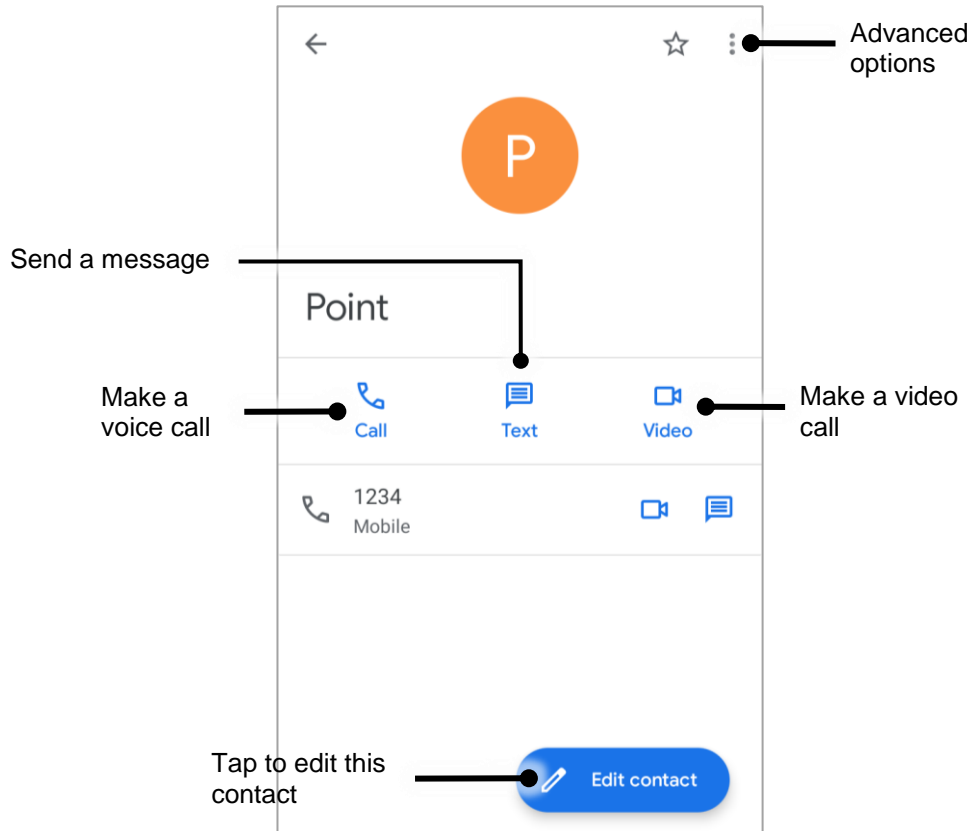



Tap  to open advanced options such as delete, share, block, etc.

Figure 39 Contact advanced options

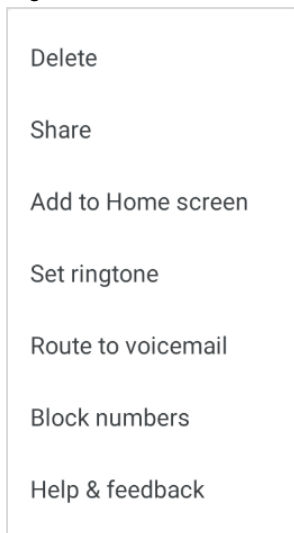

# Learning the Basics

## Message

Send a message or find the received message through Message application .



1. Launch **Message**  from App drawer.
2. Tap **Start Chat** and type the receiver's name or phone number.

Figure 40 Message list



3. Input a message.
4. Tap  icon to send.

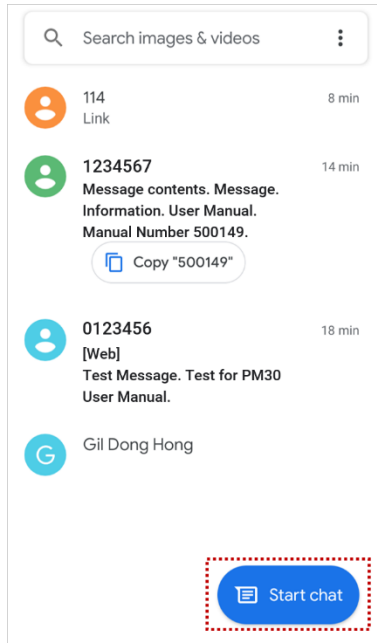

# Learning the Basics

## MTP Connection with PC

To transfer the files with a PC, connect the device to the PC via USB cable first.

1. Drag down Status bar and tap **Android System** notification to change USB preference option

Figure 41 USB connection notification

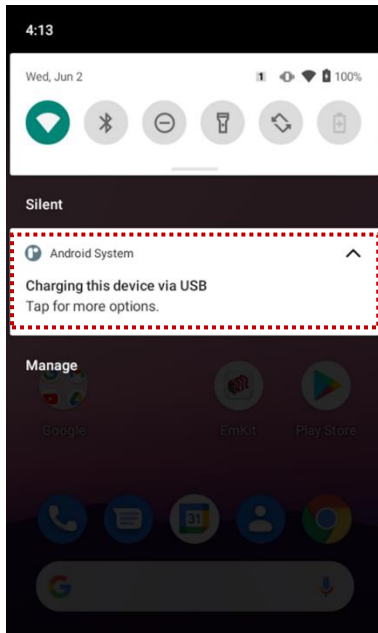

2. Change the option to **File Transfer** from **No data transfer**.

Figure 42 USB Preferences setting

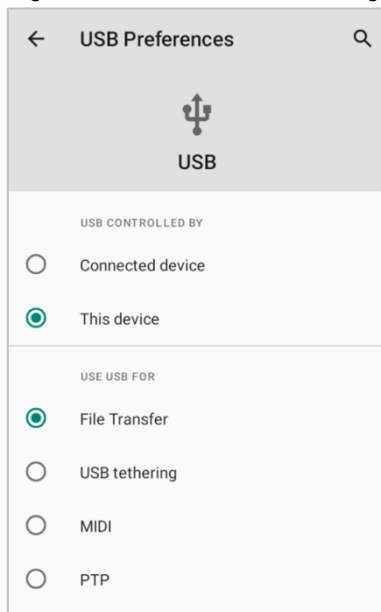

# Learning the Basics

3. Now PC can recognize the connected device. Find PM67 device from file explorer of the PC.

Figure 43 File explorer on PC



## Manage the Files

Figure 44 FileExplorer main screen

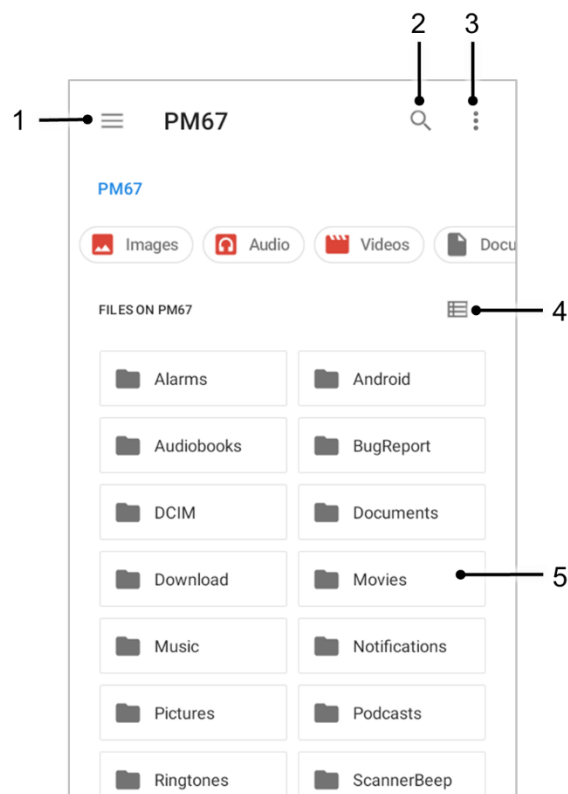

No	Description
1	Select media file type or storage
2	Search a file
3	Open the advanced option – Create a new window or folder, Select all files and folders, etc.
4	Change the view of file list
5	Tap a file or folder to open. Or long-press a file or folder to select

# Learning the Basics

Long-press a file (folder) or tap the icon which is located beside of file name to select the file (folder).

Figure 45 FileExplorer screen when file selected

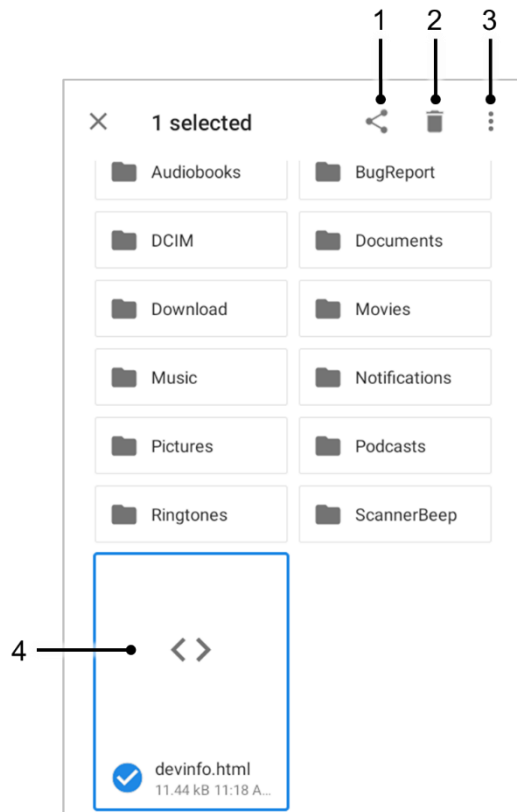

No	Description
1	Share the file via Bluetooth / Gmail / Google Drive, etc. Sharing is possible only with files
2	Delete the files or folders
3	Open the advanced option <ul style="list-style-type: none"> <li>- Open with: Select which app to open the file</li> <li>- Sort by...: Sort the list by file name, size, type, etc.</li> <li>- Select all: Select all files and folders</li> <li>- Copy / Move to: Copy or move the file to a new location</li> <li>- Compress: Create Zip file with the selected files or folders</li> <li>- Rename: Rename the file or folder</li> <li>- Get info: Display the file information</li> </ul>
4	Selected file or folder is highlighted

# Learning the Basics

---

## Lock the Screen

Protect the device from unauthorized personnel by setting up the screen lock.



1. Navigate to **Settings**  > **Security** .
2. Tap **Screen lock**.

Figure 46 Screen lock



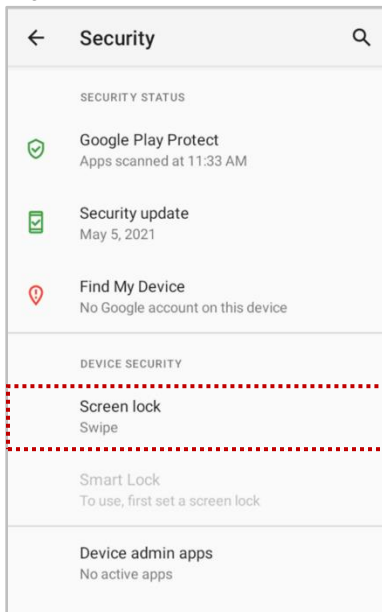

3. Choose a screen lock method.
  - None: Screen unlocks immediately
  - Swipe: Swipe the lock screen to unlock (Default)
  - Pattern: Draw a pattern to unlock
  - PIN: Input a PIN to unlock (At least 4 digits)
  - Password: Input a password to unlock (At least 4 characters)

# Learning the Basics

## Settings

There are two ways to go to **Settings**:

- Open the App drawer and tap **Settings** 
- Open the Quick setting panel and tap gear icon 

## Adjust display brightness

To adjust the display brightness level,



- Open Quick setting panel and adjust display brightness bar
- Go to **Settings**  > **Display**  > **Brightness level**

Figure 47 Normal brightness level



Figure 48 High brightness level (higher than 80%)



**Caution:** Using high brightness levels for long periods may cause eye strain and increase battery consumption.

## Adjust sound



To adjust sound volume, go to **Settings**  > **Sound**  and control the Media, Call, Ring, Alarm volume bars.

Figure 49 Volume bars



**Caution:** Using high volume levels for long periods may cause ear strain and increase battery consumption.

# Learning the Basics

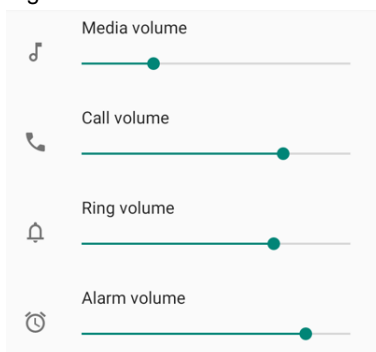
---

## Use Keyboard Backlight

The buttons in the keypad may not be visible in the dark. For this inconvenience, PM67 have keyboard backlight so that you can find the proper keys easily.

To use the keyboard backlight,



1. Go to **Settings**  > **Display** 
2. Tap **Keyboard Backlight** switch.

Figure 50 Keyboard Backlight



# Learning the Basics

---

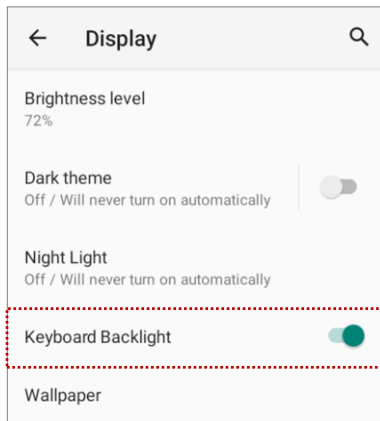
## Adjust font size

If the font size of the screen is too small or too large, adjust the font size.



1. Go to **Settings**  > **Display** 
2. Tap **Advanced**
3. Tap **Font size**
4. Referring to the **Preview**, set the font size

Figure 51 Set font size





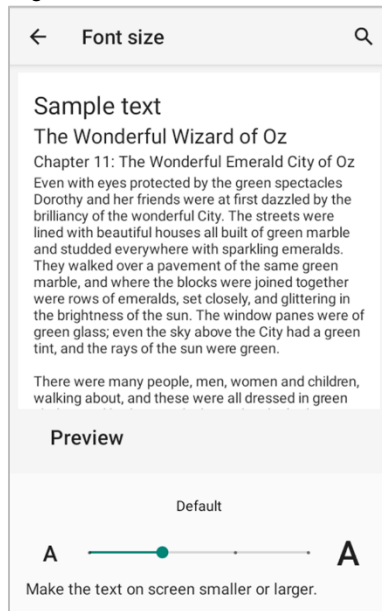

# Using the Keypad

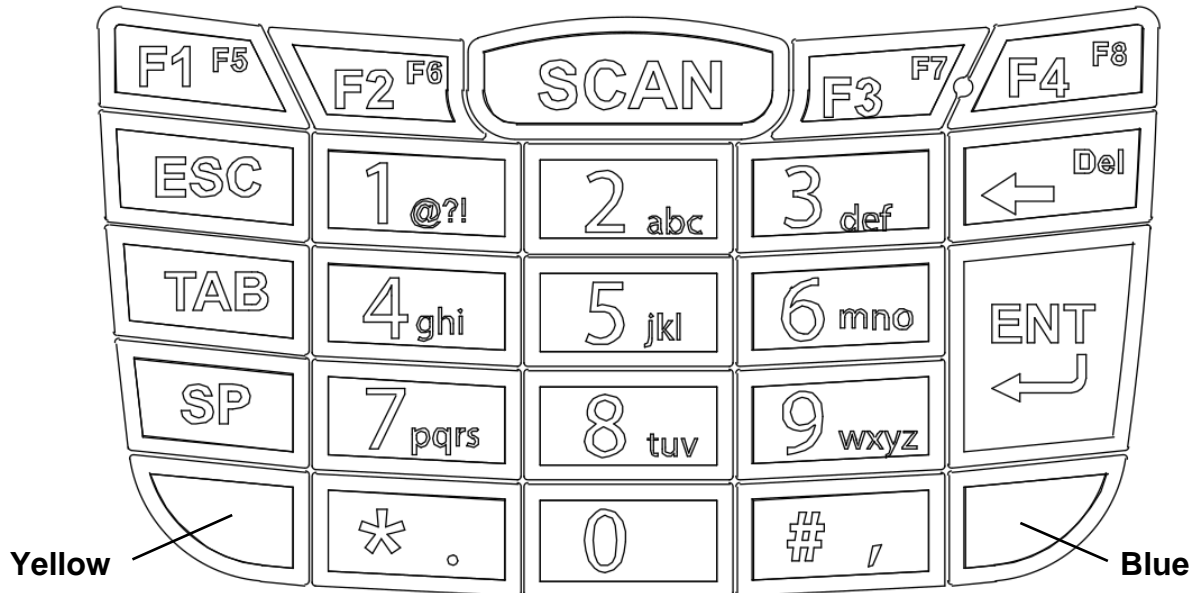
## Keypad

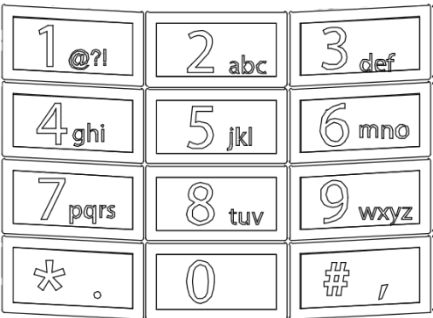
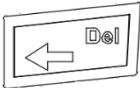
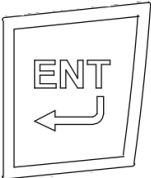

Figure 52 PM67 Keypad



Key	Description
Function 1~4 (5~8) 	Function keys F1 to F4 (or F5 to F8 in Functions input mode)
Scan 	Scan the barcode
ESC 	Escape function
Tab 	Tap function
Space 	Space function



# Using the Keypad

Key	Description
Numeric 0~9 	Numeric input mode ( <b>1</b> icon is displayed on status bar) <ul style="list-style-type: none"> <li>- Input 0 to 9</li> </ul> Alphabet input mode <ul style="list-style-type: none"> <li>- Input alphabet in uppercase or lowercase, and symbol (Character shown on the keypad in yellow)</li> </ul>
Backspace 	Backspace function
Enter 	Enter function
Alpha (Yellow) 	Press once <ul style="list-style-type: none"> <li>- Activate uppercase alphabet input mode (Shown on the keypad in yellow). The <b>A</b> icon appears on status bar</li> </ul> Press twice <ul style="list-style-type: none"> <li>- Activate lowercase alphabet input mode (Shown on the keypad in yellow). The <b>a</b> icon appears on status bar</li> </ul> Press three times <ul style="list-style-type: none"> <li>- Back to default input mode</li> </ul>
Function (Blue) 	Press once <ul style="list-style-type: none"> <li>- Activate Functions input mode (Shown on the keypad in blue). The <b>Fn</b> icon appears on status bar</li> </ul> Press twice <ul style="list-style-type: none"> <li>- Back to default input mode</li> </ul>

# Using the Keypad

## Use the Buttons

### Screen capture

To take a screenshot, press and hold the power button and volume down button simultaneously. The screenshot image will be saved to **Pictures > Screenshots** folder in the internal storage.

### Program buttons

All buttons on the PM67 except power button can be optimized as you want. To map the button to other functions from default,

1. Navigate to **EmKit**  > **Program Buttons** 
2. Select a button from the list

Figure 53 Program buttons - button list

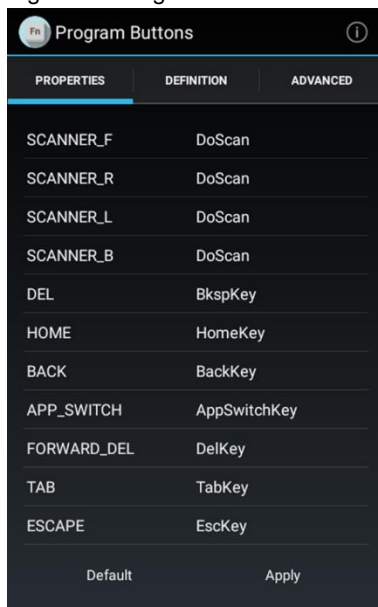

PROPERTIES	DEFINITION	ADVANCED
SCANNER_F	DoScan	
SCANNER_R	DoScan	
SCANNER_L	DoScan	
SCANNER_B	DoScan	
DEL	BkspKey	
HOME	HomeKey	
BACK	BackKey	
APP_SWITCH	AppSwitchKey	
FORWARD_DEL	DelKey	
TAB	TabKey	
ESCAPE	EscKey	

Default Apply

Refer to the figure indicating button code name in the next page.

# Using the Keypad

Figure 54 PM67 button code name

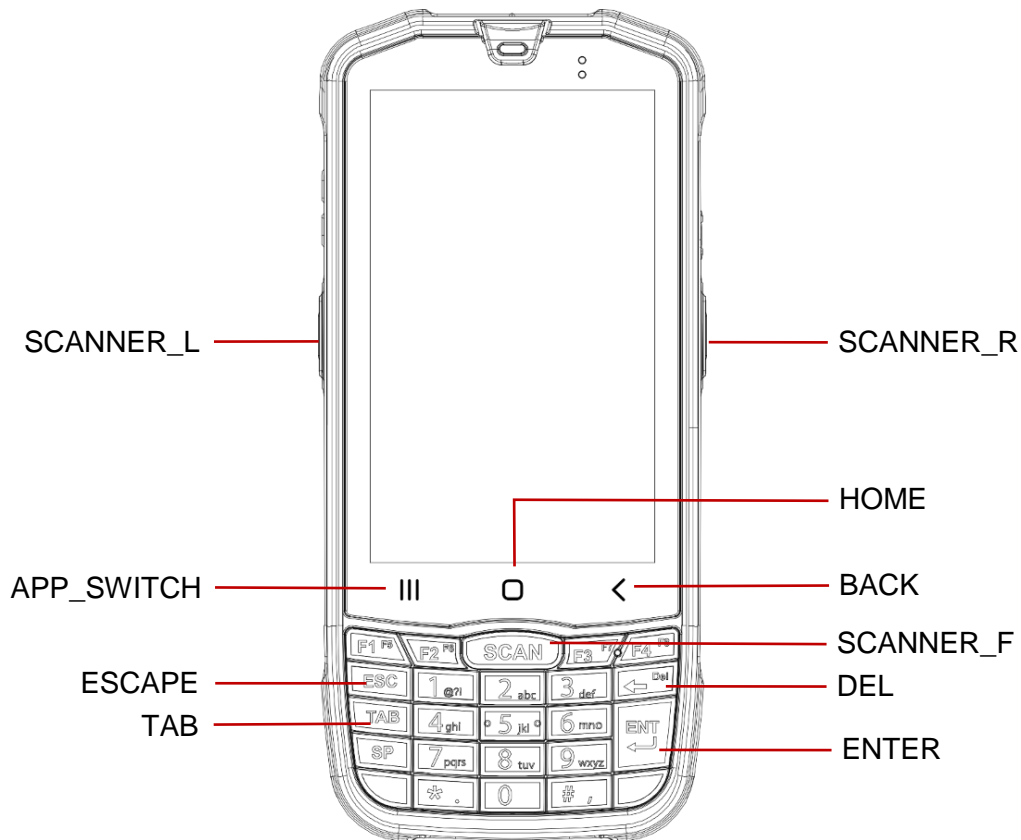

**i Note:**

- **SCANNER\_B**: Trigger button on the gun handle.
- **FORWARD\_DEL**: DEL button on the functions input mode.

3. Choose one function you want to remap
4. Tap **OK**
5. After changing all key mapping, tap **Apply** to save the changes

# Camera

PM67 has rear camera. To use the camera, open App drawer and tap Camera application .

Figure 54 is a main screen of Camera application, and Figure 55 is a screen that is displayed when you swipe the screen to right.

Figure 55 Camera main screen

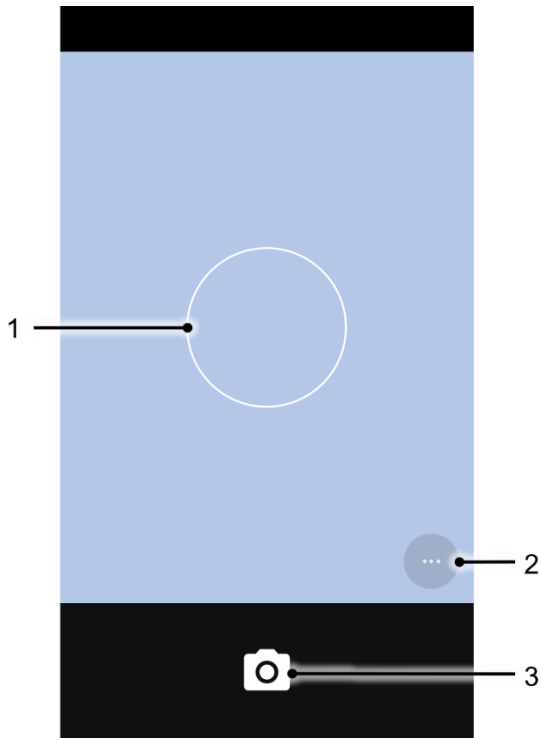
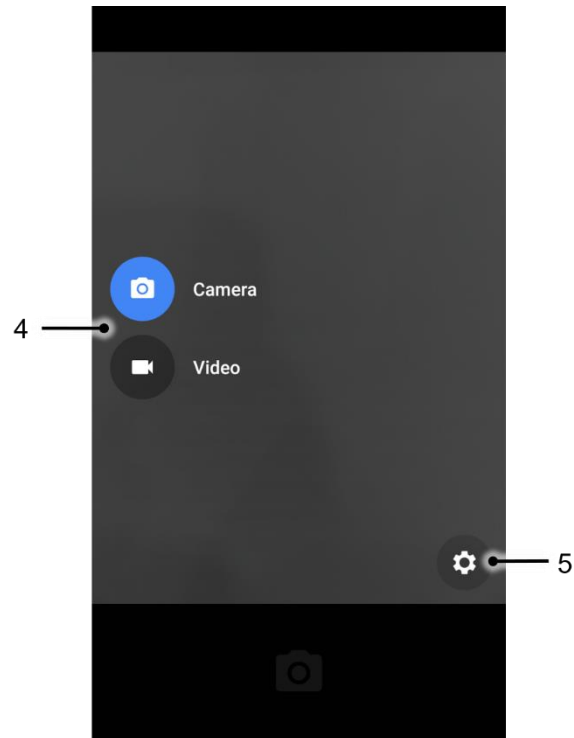





Figure 56 Camera mode change/setting screen



No	Name	Description
1	Focus zone	You can change the focusing area by touching the other area
2	Advanced camera option	 : Set timer  : Display the grid on the screen  : Set flash mode (Activate / Deactivate / Auto mode)
3	Shutter button	Take a picture or recode a video
4	Mode change button	Change the Camera or Video mode
5	Advanced camera setting	Set resolution & quality of picture Enable / Disable saving location and manual exposure

# Scanner

Scanner is placed on the top of the PM67. Optimize the scanner settings for working environment and improve the efficiency.

Figure 57 PM67 scanner location

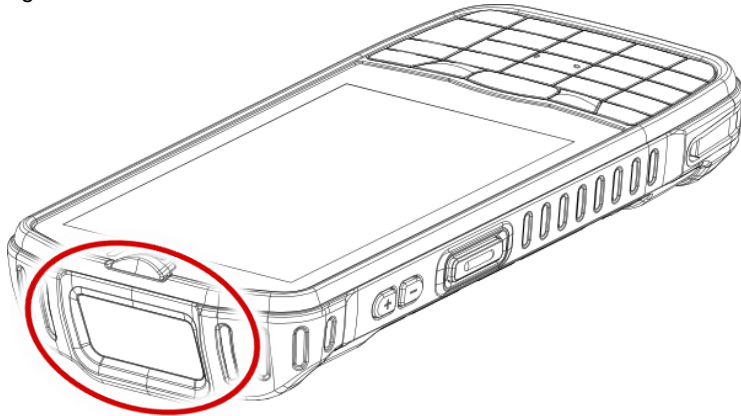

## Turn on / off the Scanner

The scanner is turned off by default. To turn on the scanner, follow the steps.



1. Go to **EmKit**  or **Settings**  and tap **ScanSettings**.
2. Tap toggle button to turn on/off the barcode scanner.
3. Check if the scanner icon (  ) is placed on Status bar.

Figure 58 Turn on scanner



# Scanner

## ScanSettings

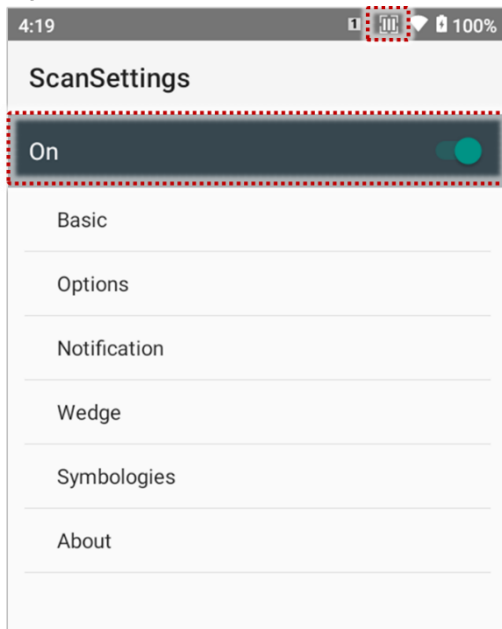
When the scanner is turned on, scanner setting menus will be displayed. **ScanSettings** consists of

- Basic
- Options
- Notification
- Wedge
- Symbologies
- About

### Basic

Control the scanning options and wedge mode options.

#### 1. Scanning

- Change the scanner's trigger timeout and set Auto scan & Continuous scan.
- Enable or disable the TouchScan, which is a software scanner button. Place a scan icon in any position and tap the icon to read a barcode.

Figure 59 ScanSettings - Basic

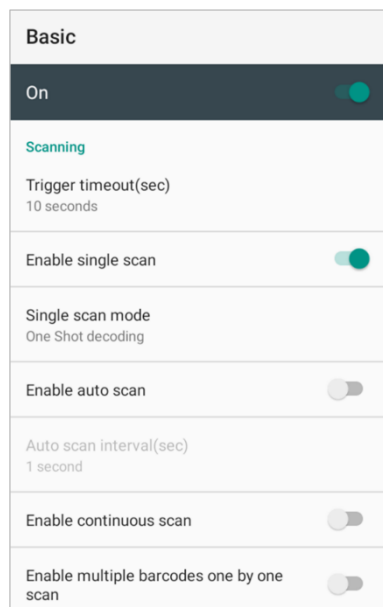
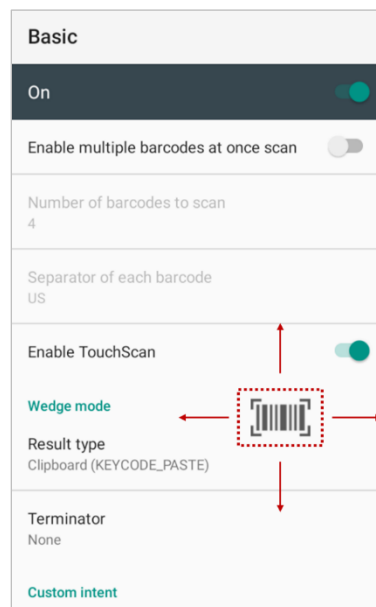

Figure 60 ScanSettings - TouchScan



# Scanner

---

## 2. Wedge mode

- Change the result type of decoded data among the below list.
  - User Message
  - Keyboard Event
  - Clipboard (KEYCODE\_PASTE)
  - Clipboard (Ctrl + V)
  - Intent Broadcast
  - Custom Intent
- Set Terminator as,
  - None
  - Space
  - Tab
  - LF
  - Tap & LF

## Options

- Enable / Disable the center window, Aimer, Illumination.
- Set Decode mode & Power save mode.

Figure 61 ScanSettings - Options

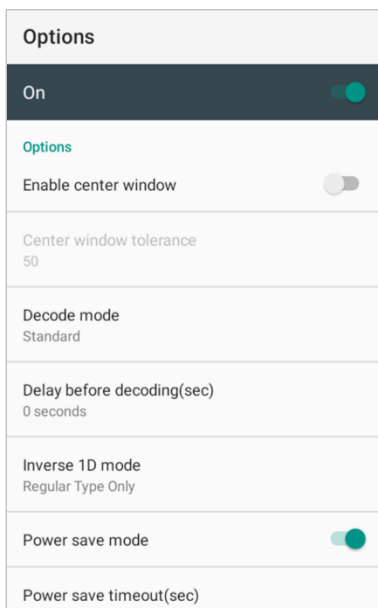

# Scanner

---

## Notification

Control the beep sound, LED and vibration option.

Figure 62 ScanSettings - Notification

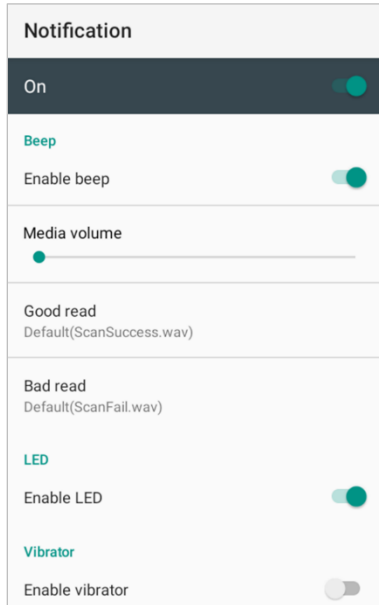



# Scanner

---

## Wedge

Set below items in Wedge settings

- Barcode ID
- Aim ID
- Group separator
- Prefix
- Suffix
- Character set
- Extended Wedge

Figure 63 ScanSettings - Wedge

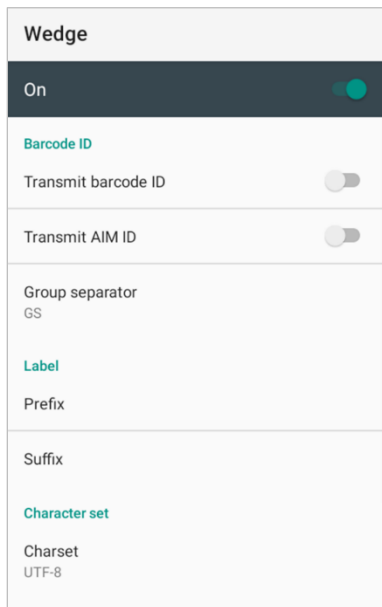

# Scanner

## Extended wedge

PM67 supports Extended wedge that allows to edit the decoded data. Tap **Enable extended wedge** toggle switch and then set a rule in **Configuration extended wedge**.

Figure 64 ScanSettings - Extended wedge

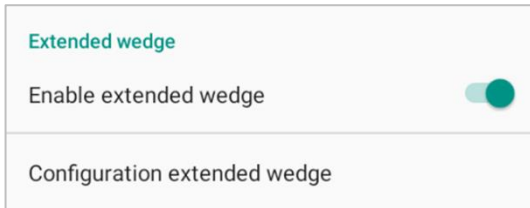

For example, make a rule that add a string “*Point Mobile*” at the start of decoded data whenever decoding CODE128.

1. Tap **Style** (1) and select **Condition** (2).

Figure 65 Extended wedge example\_1

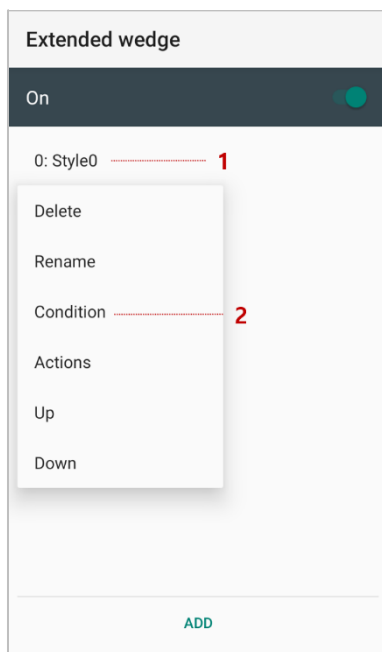

# Scanner

2. Tap **Symbologies** and select **CODE128** among the symbologies.

Figure 66 Extended wedge example\_2

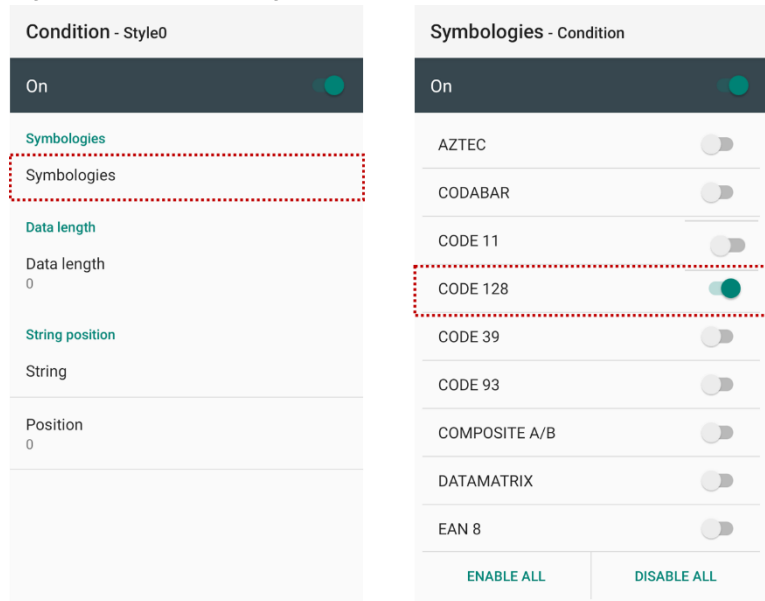

3. Tap **Style (1)** and select **Actions (2)**.

Figure 67 Extended wedge example\_3

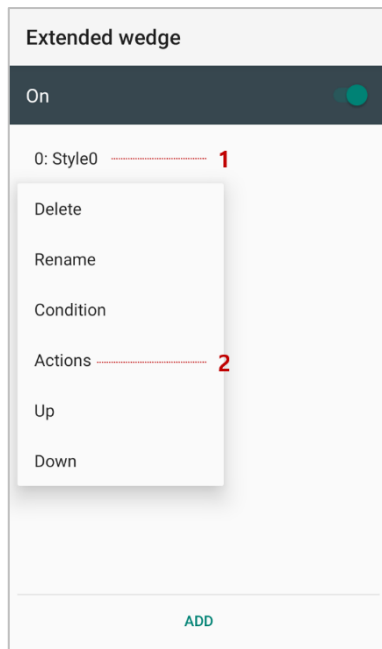

# Scanner

4. Tap **ADD** and select **Move to start** to point the start of the decoded data.

Figure 68 Extended wedge example\_4

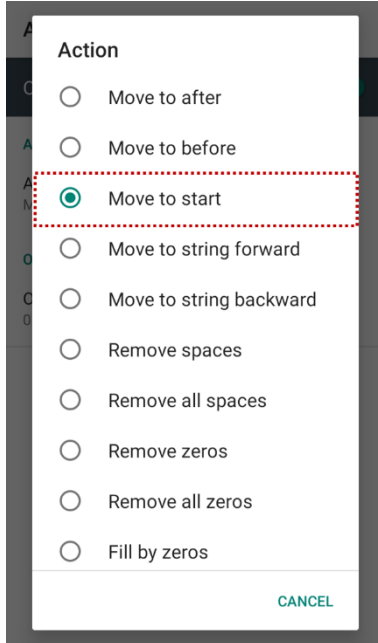

5. Add another action of which action type is Send string. Set value as “*Point Mobile*”.

Figure 69 Extended wedge example\_5

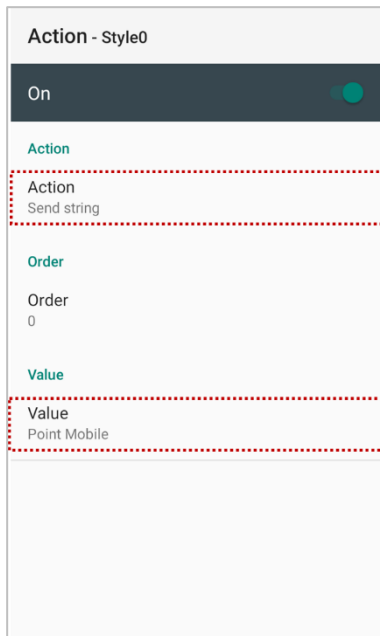

# Scanner

6. "Point Mobile" string will be added to decoded CODE128 data.

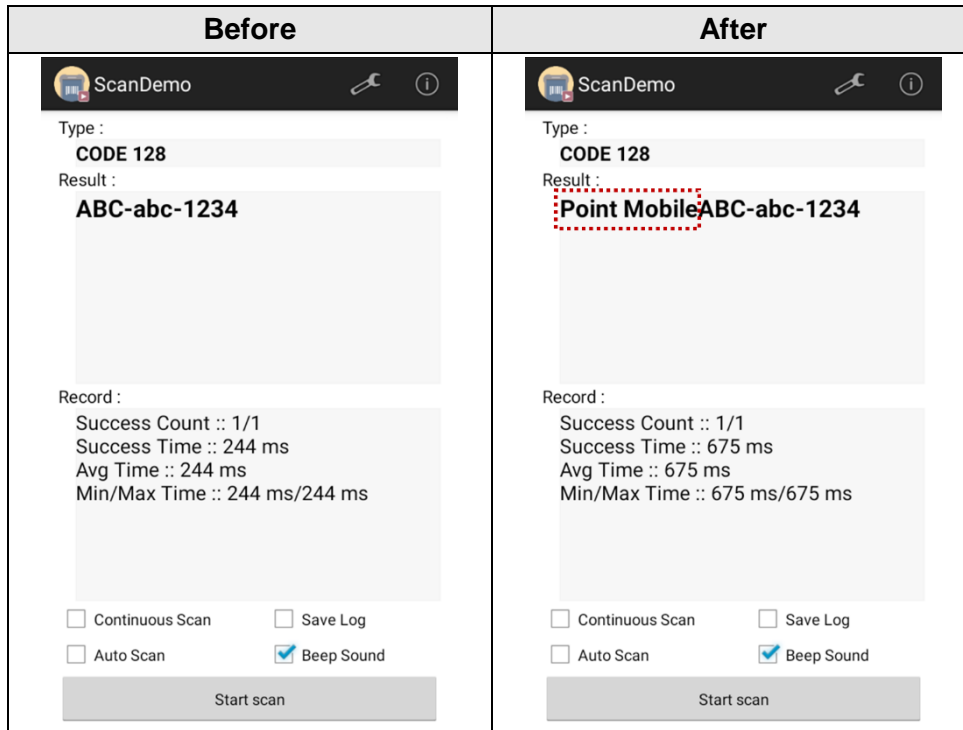

# Scanner

## Symbologies

Enable or disable the specific symbology or set detail options. By tapping each symbology name to access detail options.

Figure 70 ScanSettings - Symbologies

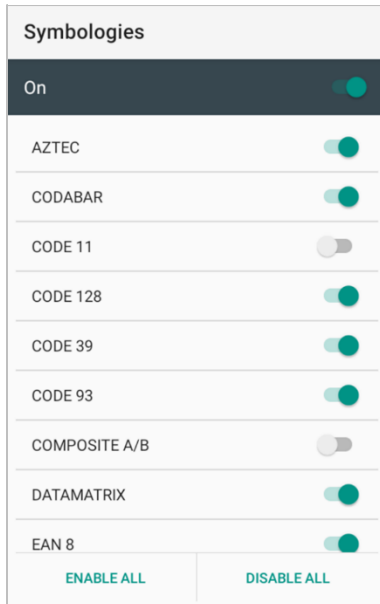

## About

Find the scanner information or restore the scanner settings to default.

Figure 71 ScanSettings - About

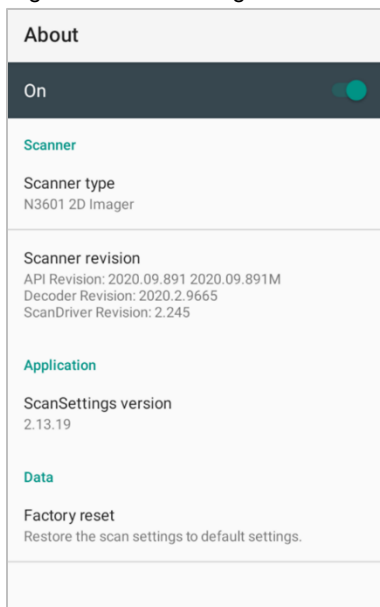

# Scanner

## Scan a Barcode

Point the scanner at the barcode and press any scan button on the PM67. If another button is set as scan trigger using Program buttons (Refer to [Use the Buttons – Program buttons](#)), it can trigger the scan action, too.

Figure 72 PM67 default scan button

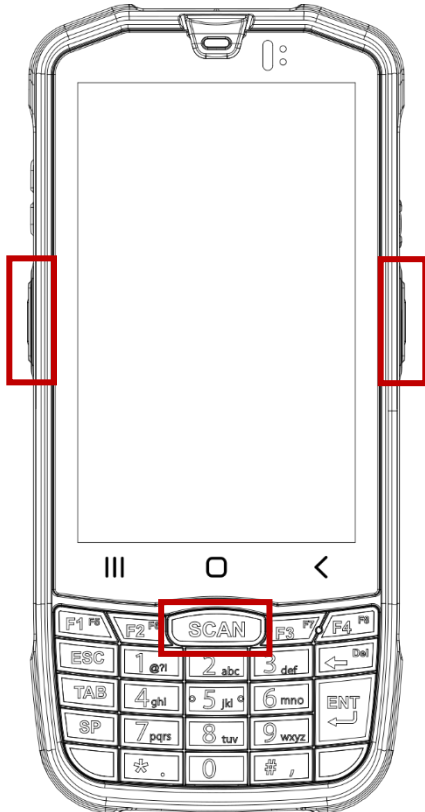

## N3601 Scanner SKU (SKU1, SKU2)

Center the green dot aimer over the barcode. The entire barcode must be inside the illumination square.

Figure 73 Aiming barcode (N3601)

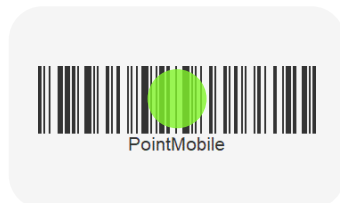

# Scanner

## N6603 Scanner SKU (SKU3)

Center the cross-hair laser aimer over the barcode. The entire barcode must be inside the illumination square.

Figure 74 Aiming barcode (N6603)



## ScanDemo

Using Scan Demo app, demonstrate the scanning feature.



1. Execute **EmKit**  > **ScanDemo** .
2. Scan a barcode by pressing the scan button on the device or tapping **Start scan** button on the screen.
3. Find scan result

Figure 75 ScanDemo



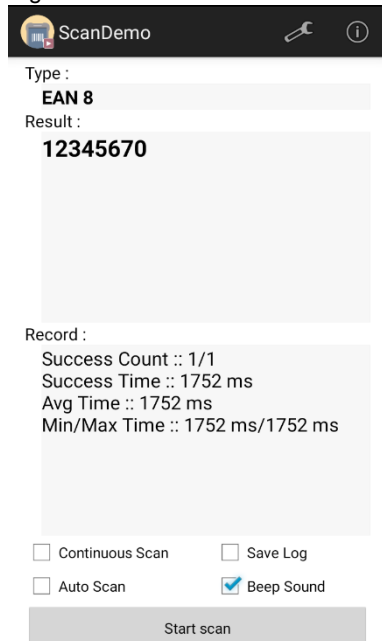

# Wireless

## Mobile Network (LTE SKU Only)

**Note:** Mobile network is supported on PM67 LTE SKU (SKU2, SKU3) only. Check your PM67 is LTE SKU.

To connect mobile network, SIM card is required. Insert SIM card into PM67 first referring [Install SIM & SD card](#).

After inserting the SIM card, reboot the device. When network is connected, a network icon will be appeared on the status bar.

Figure 76 Mobile network icon

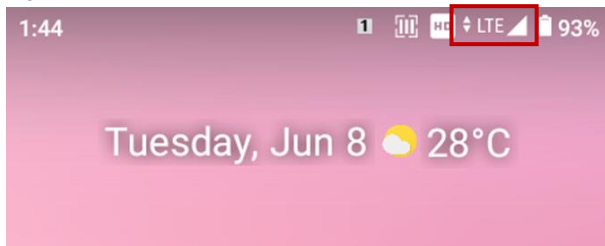

Find network information and adjust the network settings in **Settings**  > **Network & internet** .

Figure 77 Mobile network setting

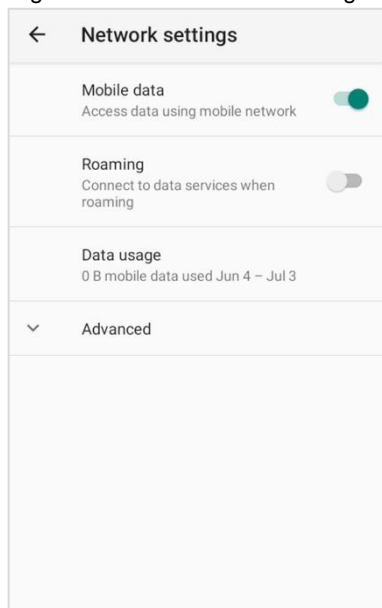
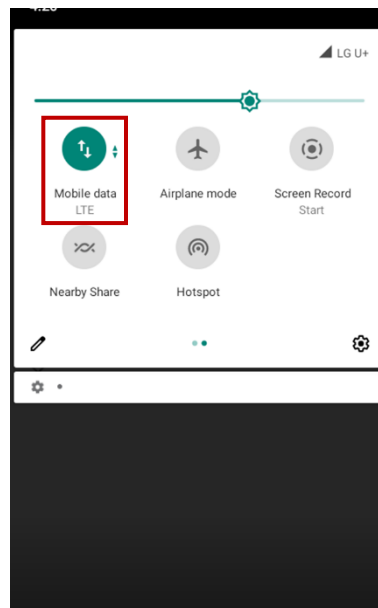

Figure 78 Quick setting panel - mobile network



This setting menu can also be accessed by long-press the Mobile data icon in Quick setting panel.

# Wireless

## Wi-Fi

To turn on and connect a Wi-Fi,



1. Go to **Settings**  > **Network & internet**  > **Wi-Fi**.
2. Tap toggle button to enable Wi-Fi.
3. Device searches for nearby Wi-Fi signals and lists them in order of signal strength.
4. Select a Wi-Fi SSID to connect.
5. The message **Connected** under the SSID means the device complete to connect to the Wi-Fi.

Figure 79 Wi-Fi connected



**Note:** There are Open Wi-Fi network and Secured Wi-Fi network. You can tell those apart by lock icon (🔒) in the nearby Wi-Fi list.

To connect the secured Wi-Fi network, you need to enter the password.

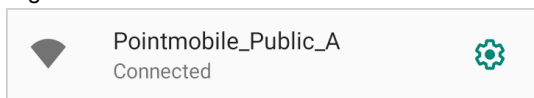
Figure 80 Open Wi-Fi Network

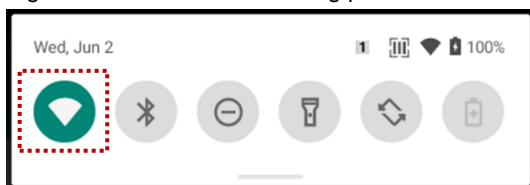

Figure 81 Secured Wi-Fi Network



If there is a saved Wi-Fi network, simply turn on the Wi-Fi through the Quick setting panel. The saved network will be connected automatically.

Figure 82 Wi-Fi in Quick setting panel



# Wireless

## Bluetooth

### Turn on / off

Bluetooth is turned off as default. There are two ways to turn on the Bluetooth,

- Open quick setting panel and enable Bluetooth 

Figure 83 Bluetooth in Quick setting panel



- Go to **Settings**  > **Connected devices**  > **Pair new device**

### Pair and Connect

Bluetooth is turned off as default. To turn on the Bluetooth and connect with a new device,



1. Go to **Settings**  > **Connected devices** .
2. Tap **Pair new device**.  
(Bluetooth will be turned on automatically)
3. Select the device you want to pair among **Available devices** list.

Figure 84 Bluetooth available devices



4. Follow instructions on the screen (Pairing code or pairing confirmation dialog) and tap **PAIR**.

# Wireless

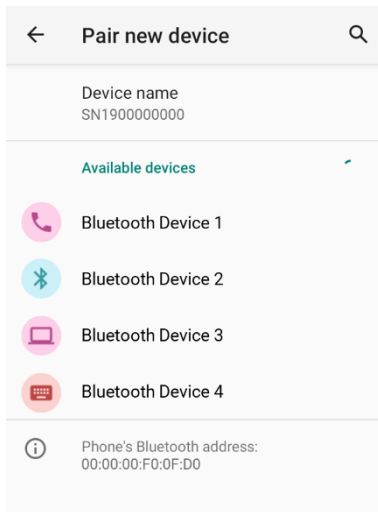
5. When the connection is succeeded, the connected device name is listed in **CURRENTLY CONNECTED**

Figure 85 Bluetooth currently connected

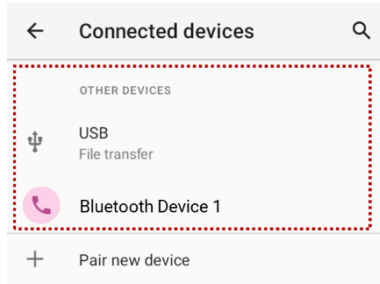

To connect a device previously connected, select the device name from the **PREVIOUSLY CONNECTED DEVICES** list.

Figure 86 Previously connected devices

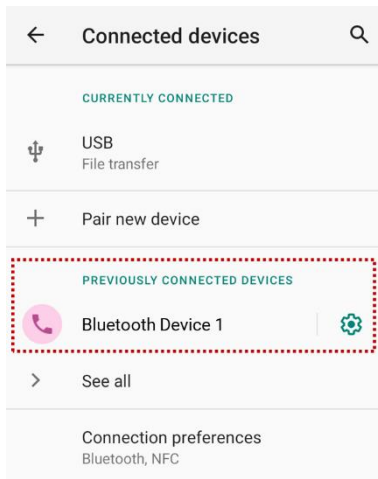

## Unpair and Disconnect

To unpair the device, select the name of the device you want to unpair from **CURRENTLY CONNECTED** list and tap **FORGET** .

Or tap **DISCONNECT**  to disconnect only and not unpair.

Figure 87 Forget device



# Wireless

## Change the Bluetooth device details

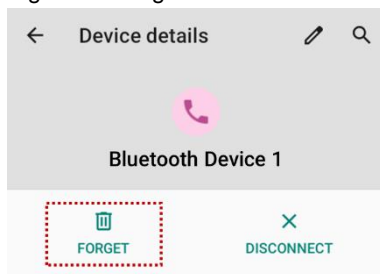
Select a device name from **CURRENTLY CONNECTED** or tap  icon next to the device name from **PREVIOUSLY CONNECTED DEVICES** list.

If no devices are listed under the **PREVIOUSLY CONNECTED DEVICES**, tap **See all**.

Figure 88 Bluetooth device detail

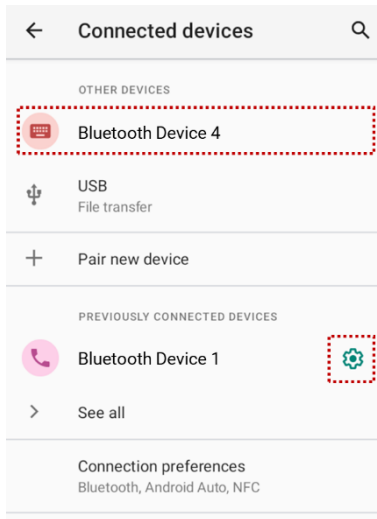

- To change the device's name, tap  on the top of the screen
- Turn other settings on or off (Available on some devices)

# Wireless

## NFC (NFC SKU Only)



**Note:** NFC is supported on PM67 SKU2, SKU3 only. Check your PM67 SKU supports NFC feature.

NFC feature is enabled by default. But if NFC does not work, make sure the NFC  is enabled from the Quick setting panel.

PM67's NFC antenna is located on the battery cover. Bring the NFC tag close to the center of the battery cover (Rear side of the device) as below.

Figure 89 PM67 NFC tagging area



Figure 90 NFC tagging

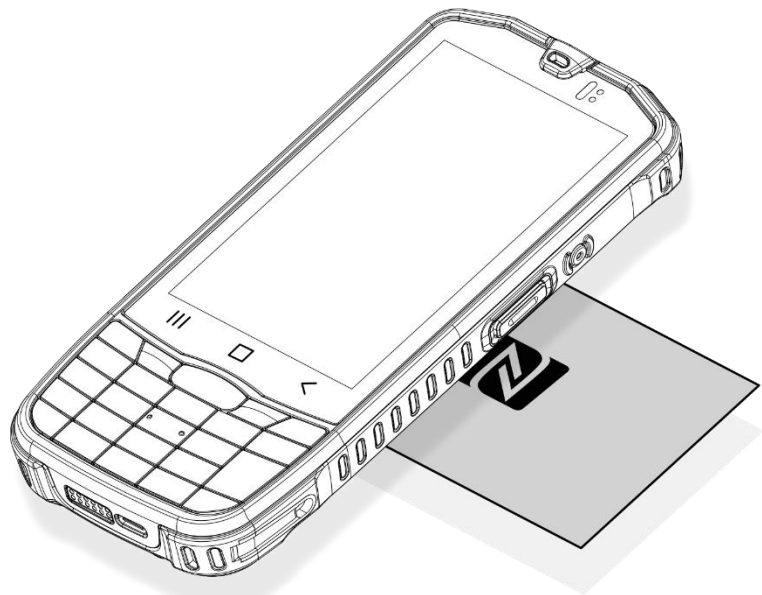

# System Maintenance

---

## System Information

There are two ways for checking system information, on settings and on EmKit.

### On Settings

Go to **Settings**  > **About phone** . Following information can be found.

- Device name
- Phone number
- Emergency information
- Legal information & Certificates
- Model & SIM status
- Hostname
- Android version
- IMEI
- IP address
- Wi-Fi MAC address
- Bluetooth address
- Build number

### On EmKit

Go to **EmKit**  > **System Information** . Following information can be found.

- Processor information
- Version information (Android version, OS image version, SDK version, etc.)
- Manufacturer information (Serial number, Part number, etc.)
- Device information (Scanner, Camera, Audio, Display, etc.)
- Battery information (Battery charging status, etc.)
- App version information (Version of EmKit apps)

# System Maintenance

## Check Device Health

EmHealthReport is a solution that provides the device's battery and eMMC health.

Monitor the battery and eMMC status to foresight their lifetime or find the cause when there is a battery problem such as cannot charge the device or rapid battery discharge.



To use, open **EmKit**  and launch **EmHealthReport** . You can see the simple device health information on main screen. To find detailed information, tap each blue arrow on the right side of the screen.

Figure 91 EmHealthReport



- **Battery Health**
  - Battery Level
  - Battery Health
  - Battery Voltage
  - Battery Temperature
  - System Temperature
- **eMMC Health**
  - Pre-EOL Information
  - Device life time estimation type A
  - Device life time estimation type B

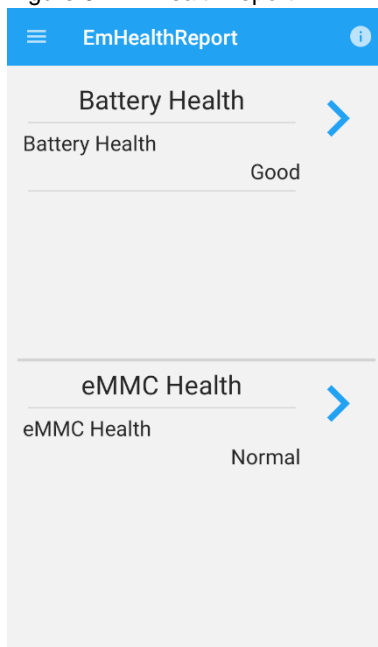

# System Maintenance

## OS Update

Periodic update improves the performance of the device. Point Mobile provides up-to-date OS version via Service Portal and FOTA. Update the device via storage, OTG port, and FOTA server. Depending on the workspace environment, choose more suitable method.



**Notice:** Please backup your data before starting the update process.

### OS update via storage

To update the OS using storage,



1. Download an OS image file into the root folder of microSD card or device internal storage
2. (In case of using SD card) Insert SD card to the device and then turn the device on
3. Go to **Settings**  > **System**  > **Advanced** > **System Update**
4. Check if the OS image file shows up under **AVAILABLE VERSIONS**

Figure 92 OS update via storage



5. Tap **UPDATE** to start the update process



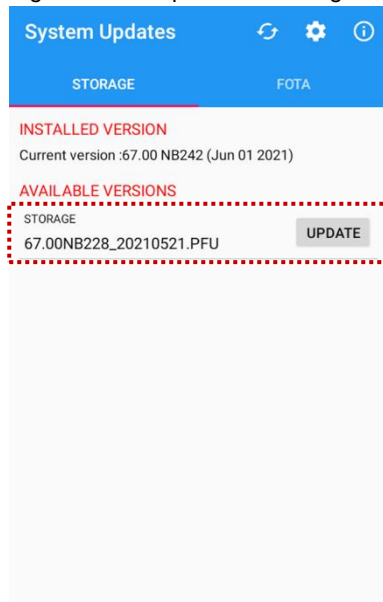

**Note:** If the OS image file doesn't show up in **AVAILABLE VERSIONS**, check the file is placed in the root folder of storage. System only can recognize the file in the root folder.

# System Maintenance

## OS update via OTG port

PM67 supports the USB OTG feature.

1. Prepare a formatted USB flash drive for OS update
2. Copy an OS image file to the root folder of the flash drive
3. Connect the flash driver to the PM67
4. Go to **Settings**  > **System**  > **Advanced** > **System Update**
5. Check if the OS image file shows up under **AVAILABLE VERSIONS**
6. Tap **UPDATE** to start the update process

## OS update via FOTA

If PM67 can connect to a network, use the FOTA server for the update.



1. Connect the device with a network
2. Go to **Settings**  > **System**  > **Advanced** > **System Update**
3. Tap **FOTA** tab or Swipe left to move to **FOTA** tab
4. If there is an OS version newer than device's one, the server shows the new OS information

Figure 93 OS update via FOTA



# System Maintenance

---

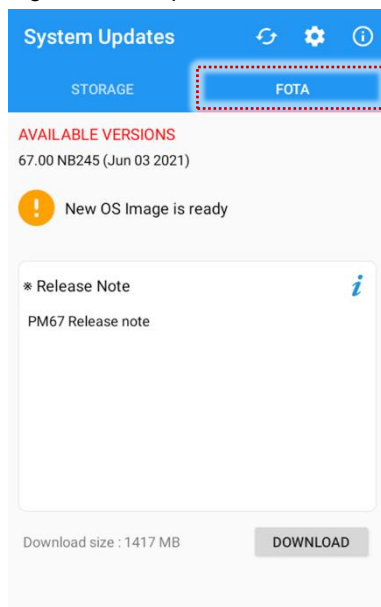
5. Tap **Download**
6. Tap **OK** on the **OS Update** dialog to start to download the OS image file
7. To complete the update, rebooting is required. Tap **OK** on the **Restart required** dialog to restart the device

**Note:** Basically, OS update via FOTA works over Wi-Fi or Ethernet only. To enable the OS update over Mobile Network too, uncheck the setting value in FOTA Settings. Downloading over the Mobile network may result in additional charges.

Figure 94 FOTA Settings

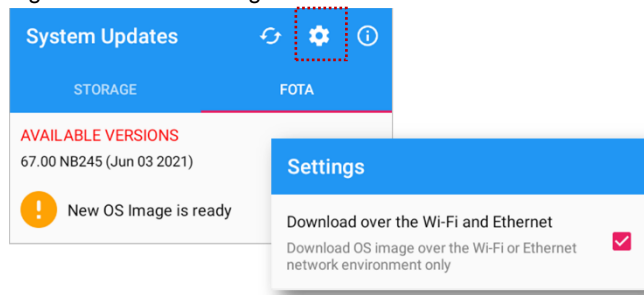

# System Maintenance

---

## Factory Data Reset

When PM67 work abnormal or there is a need to reset the device, follow the steps below to perform a factory data reset.



**Caution:** *Factory data reset will erase all personalized settings and data saved in the device, such as Google account, apps, user data, etc. And factory data reset cannot undo.*

### Factory data reset via Settings app

If the device can be turned on and access **Settings**,



1. Navigate to **Settings**  > **System**  > **Advanced** > **Reset options**
2. Tap **Erase all data (factory reset)**
3. After being aware that factory reset will erase all data from the internal storage, tap **Erase all data**

Figure 95 Factory data reset



4. Tap **Erase all data** again to start the factory reset process

# System Maintenance

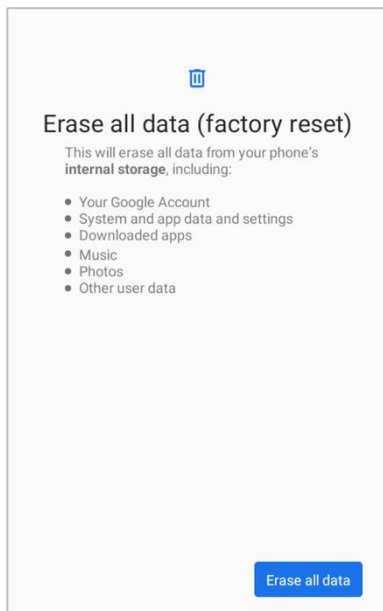
---

## Factory data reset via recovery mode

If device works abnormal so does not turn on, try to perform factory data reset through Android recovery mode.

1. Press and hold **power button + volume up + front scan** buttons simultaneously when PM67 turned off.

Figure 96 Recovery mode button combination

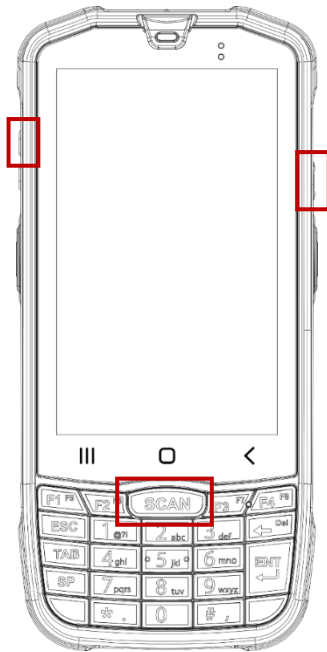

2. After short vibration, release the power button
3. Using the keys below, select **Wipe data/factory reset**
  - **Move down / up** – Press volume down / up button
  - **Select the menu** – Press power button or Enter key
4. After wiping the data, select **Reboot system now**

# Accessories

PM67 supports below optional accessories. All accessories are compatible with PM66.

Category	Accessory Name	Usage
Gun handle	Gun handle	Provide additional scan trigger button (Programmable)
Charging cradle	SSC (Single Slot Cradle) / SEC (Single Ethernet Cradle)	Charge one PM67 and one PM67 battery Provide USB type C port (SSC) or ethernet port (SEC)
	4SC (4 Slot Cradle)	Charge up to four units of PM67
	4SBC (4 Slot Battery Cradle)	Charge up to four pieces of PM67's batteries

## Hand Strap

Hand strap is delivered with already mounted on the device. To install the battery or SIM / SD card, remove the hand strap, first.

Figure 97 PM67 Hand strap

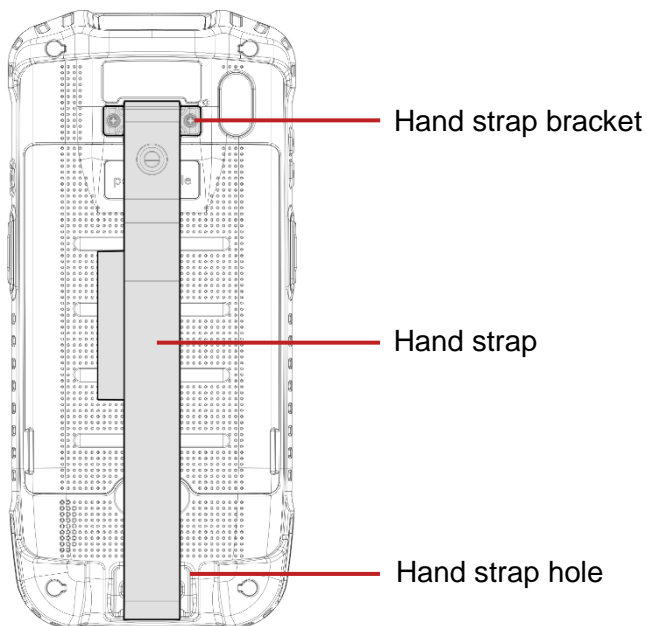

# Accessories

## Mount hand strap

1. Align the hand strap assembly part with the screw hole on the rear-top of the device.
2. Tighten the screws using a screwdriver.

Figure 98 Mount hand strap (bracket)

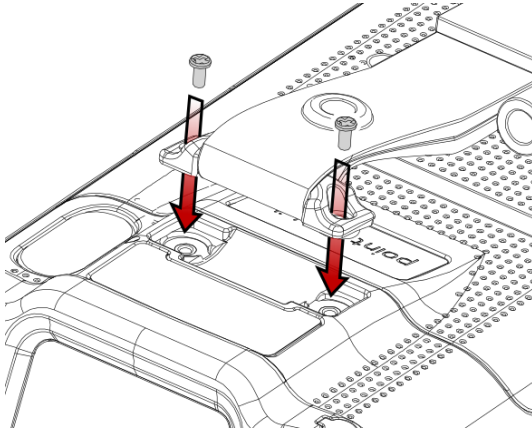

3. Pass the end of the strap through the hand strap hole.

Figure 99 Pass strap through hole

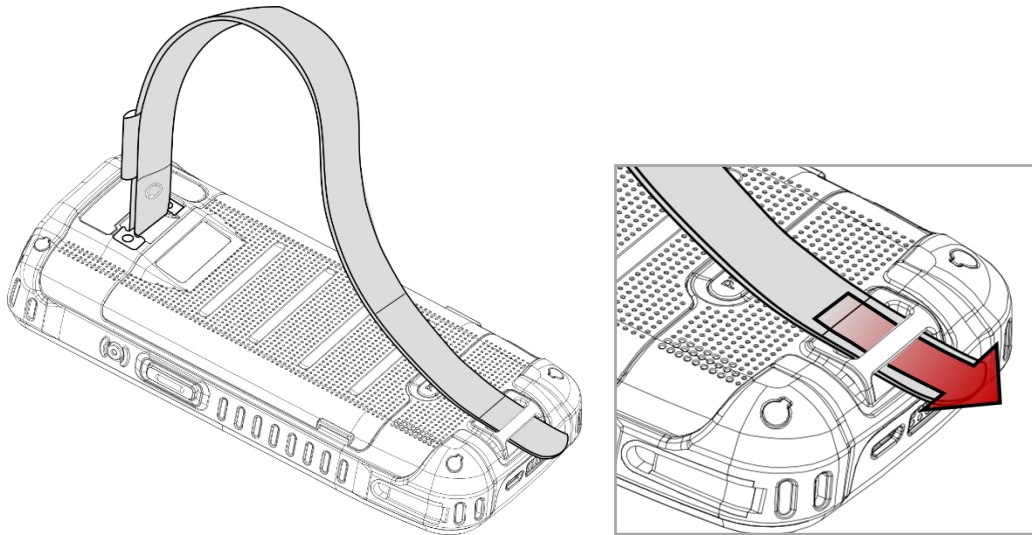

# Accessories

---

4. Pull the strap and attach the Velcro at the desired length.

Figure 100 Attach hand strap velcro

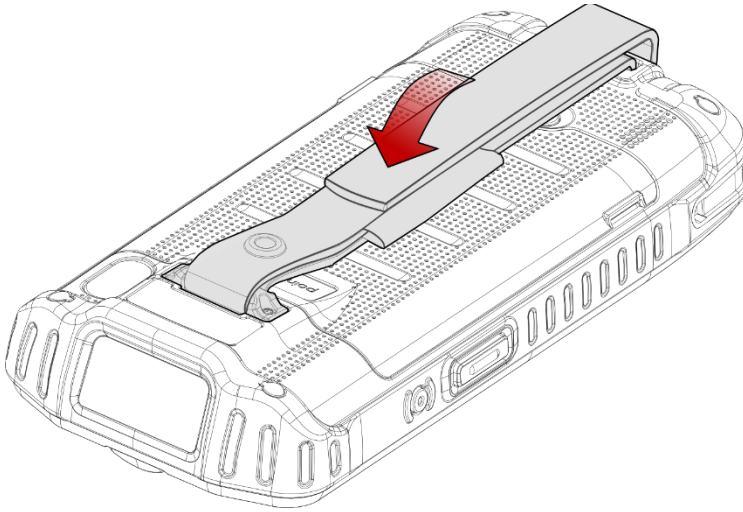

## Remove hand strap

1. Pull the end of the strap to detach the Velcro.

Figure 101 Detach hand strap velcro

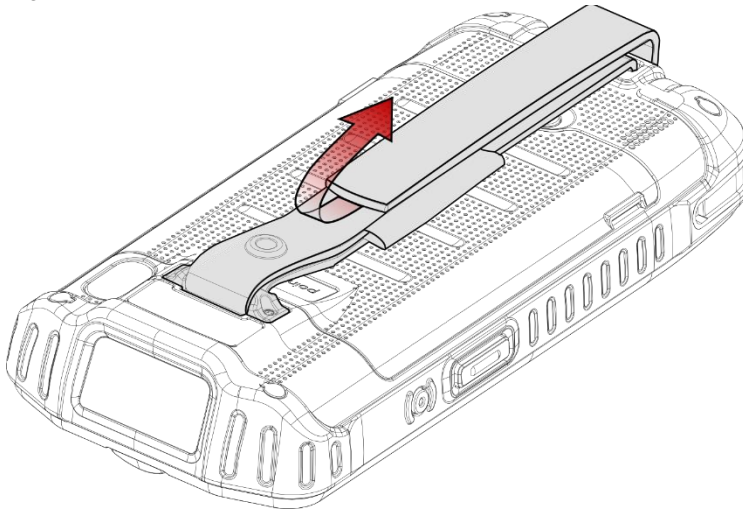

2. Pull the strap off through the hand strap hole.



# Accessories

3. If you want to remove the hand strap completely, release the screws of the hand strap bracket using a screwdriver.

Figure 102 Remove hand strap (bracket)

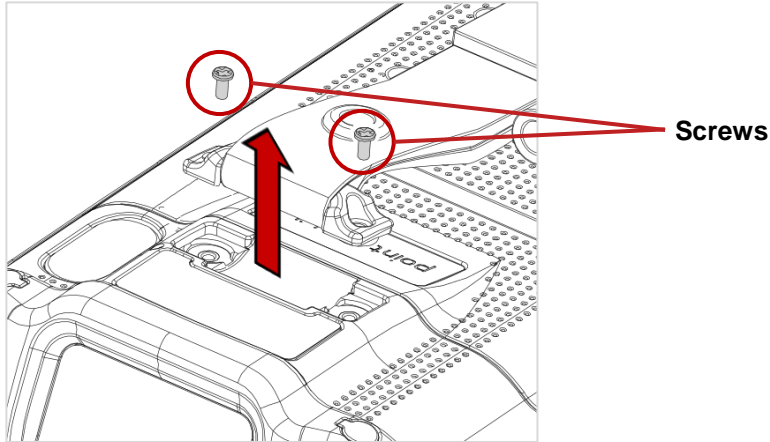

**Notice:** If you completely removed the hand strap, keep the screws for future use.

## Gun Handle

Attach a gun handle to PM67 and use additional programmable button. The button is used for triggering scanner usually.

Figure 103 PM67 gun handle

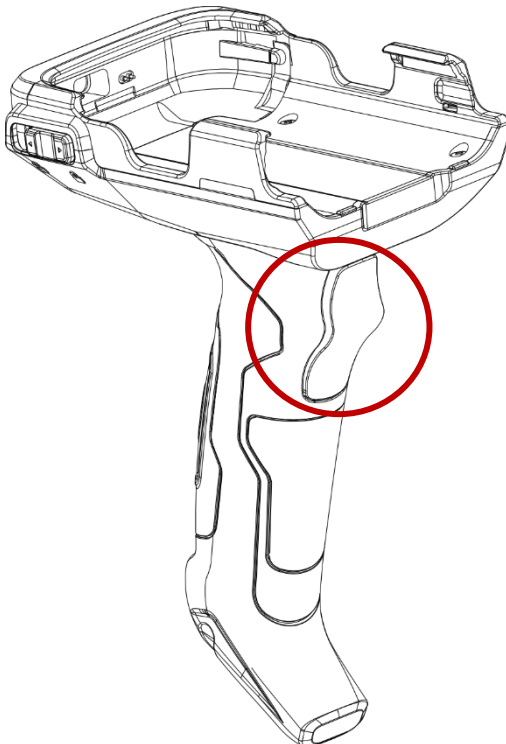

# Accessories

---

## Attach gun handle

Make sure that the lockers on either side of the gun handle are locked. They make the device engage firmly and protect the device from detaching accidentally.

1. Slide the PM67 into the retention fixture of the gun handle.

Figure 104 Attaching PM67 to gun handle

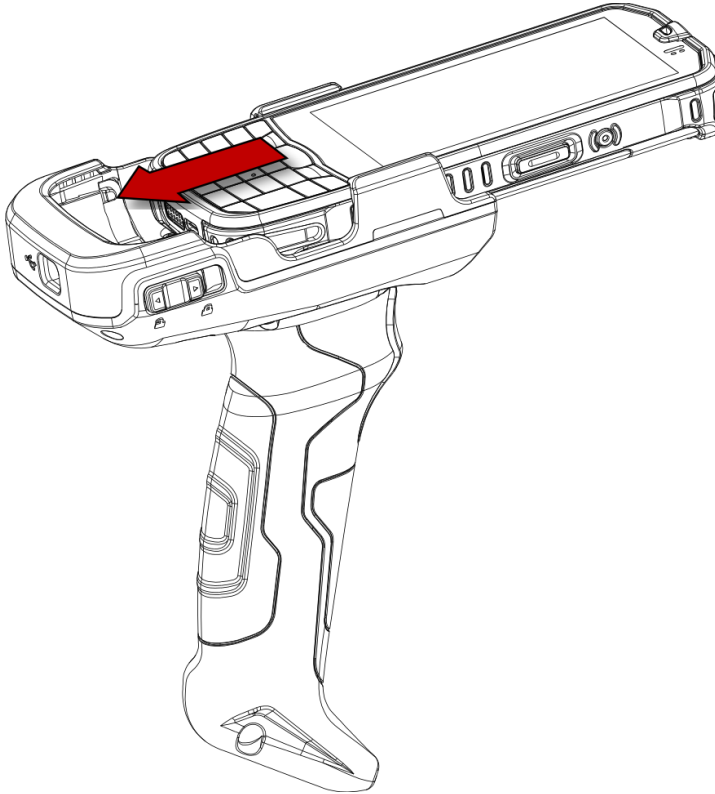

2. Lock the lockers on both sides of the gun handle to secure the device.

Figure 105 Locking the device (Right)

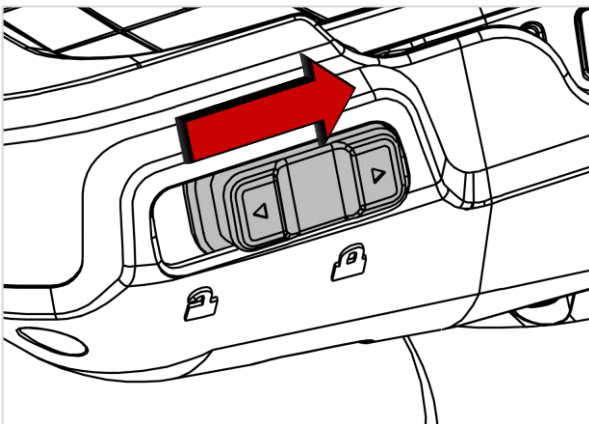

# Accessories

## Mount hand strap

Mount the hand strap enclosed in the gun handle package, and bring the device more comfortable.

1. Slide the rope into the handle side hole, first.

Figure 106 Slide into the handle side hole

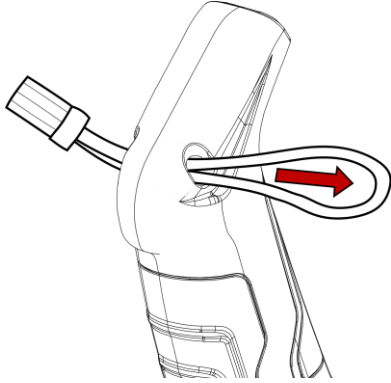

2. Pass the other end through the loop of the rope, and pull it tight.
3. Thread the strap through the fixture side hole.

Figure 107 Pass strap through the fixture side hole

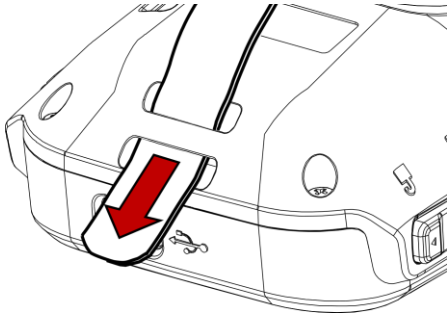

4. Slide the strap through the buckle and latch the buckle at the appropriate length.

Figure 108 Latch buckle to secure the strap

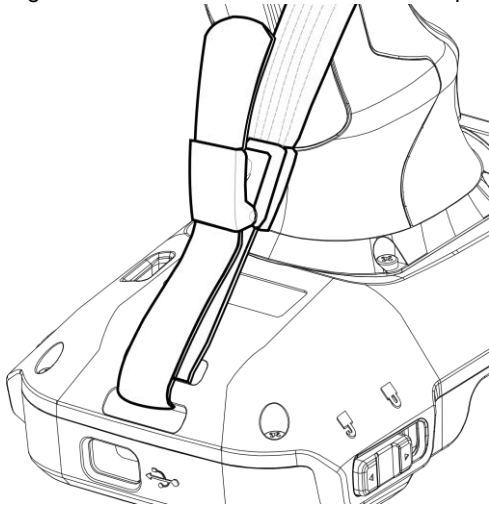

# Accessories

---

## Single Slot Cradle (SSC / SEC)

SSC / SEC has one device slot and one battery slot so that it can charge a PM67 and a battery at the same time.

In addition to the charging function, the cradles also provide a communication port as follows.

- SSC – USB Type C port
- SEC – Ethernet port

For more detail, find [Charge the device - SSC / SEC](#) chapter or SSC Quick start guide.

## 4SC (4 Slot Cradle)

4SC has 4 device slots so it can charge up to four units of PM67 simultaneously. For more detail, find [Charge the device – 4SC](#) chapter or 4SC Quick start guide.

## 4SBC (4 Slot Battery Cradle)

4SBC has 4 battery slots so it can charge up to four pieces of PM67's battery simultaneously. For more detail, find [Charge the device – 4SBC](#) chapter or 4SBC Quick start guide.

# Safety Information

---

## Battery Safety Information

Follow the battery safety guidelines for safe usage, storage, and disposal of Li-ion batteries. Improper battery use may result in a fire, explosion, or other critical hazards.

### Battery Safety Guidelines

- Use only Point Mobile approved batteries and charging accessories. Other batteries and chargers may damage the device or result in a fire, leakage, or other hazards.
- Do not expose the battery to excessive heat or cold.
- Do not use or store the battery in or near areas that might get very hot, such as in a parked vehicle, near a heat duct or close to other heat sources.
- Do not allow objects that may cause a short circuit, such as metal objects, corrosive substances, or liquids like water, to contact the battery.
- Do not disassemble, crush, bend, shred, press, or other actions that may damage or deform the battery.
- Do not use or replace the battery on the go or from a high location. Dropping may result in an explosion or fire.
- Do not put any labels, stickers, tags, etc. on the device or battery. Performance of the device or battery, such as sealing, drop, or tumble, could be affected.
- Close supervision is necessary when used near children to avoid the risk of injury.
- If battery leakage is observed, avoid any contact with the skin or eyes and properly dispose of the battery. If contact has been made, wash the affected area with water for 15 minutes and seek medical advice.
- If you notice any type of damage to the battery, such as swelling, dents, and leaks, stop using it immediately and contact Point Mobile.

### Battery Charging Guidelines

- Charge the battery in a clean, cool, dry, and ventilated environment.
- Separate the charger from the battery as soon as possible when the battery is fully charged.
- Battery performance can degrade due to the stress of daily charging and discharging. Batteries typically need to be replaced after 300 to 500 charging cycles (full charge-discharge cycles) or when the battery capacity has been reduced to 70 ~ 80% of its original capacity. The actual number of charging cycles varies based on usage patterns, temperature, age, and other factors.

# Safety Information

---

## Battery Storage / Disposal Guidelines

- Store the batteries in a clean, dry and ventilated environment within ambient temperature ranges of  $20\pm 5^{\circ}\text{C}$ .
- For safety regulations, batteries are charged to below 20~30% of full capacity during production.
- When not using batteries for a long period, charge the battery for 30 minutes to 1 hour at least once every 6 months to prevent full discharge and keep the performance.
- Batteries should be stored separately when storing for long periods. Disconnect from any device, charger, or cradle.
- Dispose of used batteries promptly according to local disposal regulations.
- Do not dispose of the battery in fire. It may cause explosion.



**Notice:** The battery is consumable. Point Mobile provides a warranty for the battery for 12 months after purchase.

If you suspect the battery swelling, change the battery immediately and contact Point Mobile.



## **Point Mobile. Co., Ltd.**

### **Offline**

Tel: +82-2-3397-7870~1

ARS: +82-1800-3010

Fax: +82-2-3397-7872

Address: 9F Kabul Great Valley, 32, Digital-ro 9-gil,  
Geumcheon-gu, Seoul, Korea 08512

### **Online**

Website: <https://www.pointmobile.com>

E-mail: [pm\\_support@pointmobile.com](mailto:pm_support@pointmobile.com)